

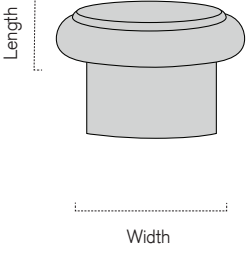
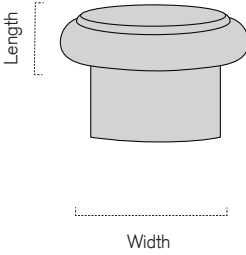
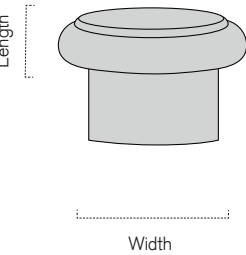
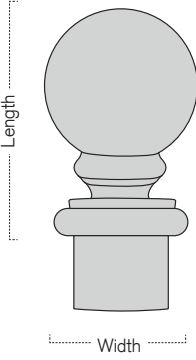

kravet **drapery** hardware

RUSTIC IRON
SPECIFICATIONS

RUSTIC IRONS - Custom

	Styles / Specifications	Available Finishes	Catalog Pg.
	<p>Iron Cap - 3/4" HDW20199</p> <p>5/16" L x 1 1/4" W Designed for 3/4" Dia. Pole</p>	<ul style="list-style-type: none"> • Bronze - 66 • Vintage - 84 • Cast Iron - 818 • Antique Gold - 418 • Rustic - 624 • Aged Silver - 106 	2
	<p>Iron Cap - 1" HDW20200</p> <p>5/16" L x 1 1/4" W Designed for 1" Dia. Pole</p>	<ul style="list-style-type: none"> • Bronze - 66 • Vintage - 84 • Cast Iron - 818 • Antique Gold - 418 • Rustic - 624 • Aged Silver - 106 	2
	<p>Iron Cap - 1 1/2" HDW20201</p> <p>3/8" L x 2" W Designed for 1 1/2" Dia. Pole</p>	<ul style="list-style-type: none"> • Bronze - 66 • Vintage - 84 • Cast Iron - 818 • Antique Gold - 418 • Rustic - 624 • Aged Silver - 106 	2
	<p>Pawn HDW20203</p> <p>2 1/8" L x 1 1/2" Dia.</p> <p><i>Works best with rods 3/4" - 7/8" diameter</i></p>	<ul style="list-style-type: none"> • Bronze - 66 • Vintage - 84 • Cast Iron - 818 • Antique Gold - 418 • Rustic - 624 • Aged Silver - 106 	2

NEW! Rustic Iron Collection can be specially treated for outdoor use with an upcharge.
(Rustic Iron Traversing cannot be treated for outdoor use.)

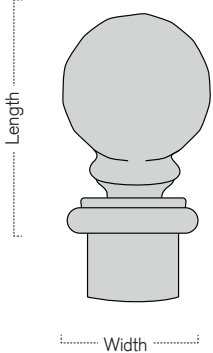
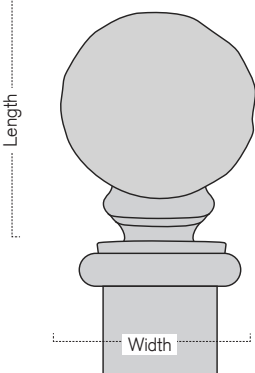
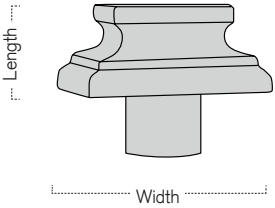
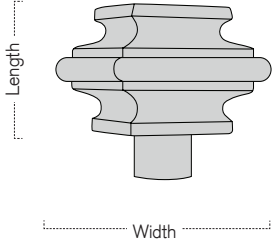

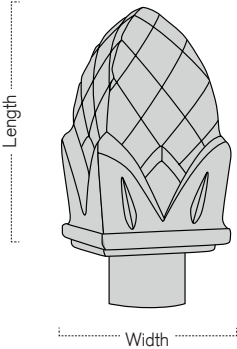
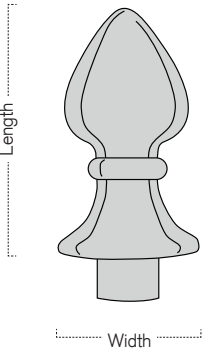
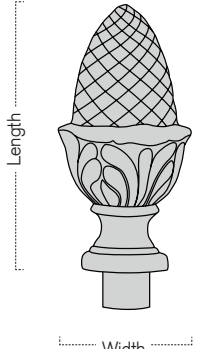
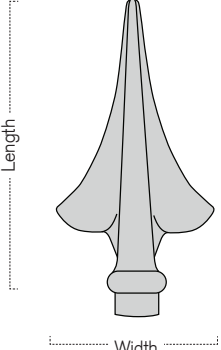

	Styles / Specifications	Available Finishes	Catalog Pg.
	<p>Hammered Pawn HDW20204</p> <p>2 1/8" L x 1 1/2" Dia.</p> <p><i>Works best with rods 3/4" - 7/8" diameter</i></p>	<ul style="list-style-type: none"> • Bronze - 66 • Vintage - 84 • Cast Iron - 818 • Antique Gold - 418 • Rustic - 624 • Aged Silver - 106 	2
	<p>Cannon Ball HDW20205</p> <p>2 3/8" L x 2" Dia.</p> <p><i>Works best with 1" or larger rod diameter or square</i></p>	<ul style="list-style-type: none"> • Bronze - 66 • Vintage - 84 • Cast Iron - 818 • Antique Gold - 418 • Rustic - 624 • Aged Silver - 106 	2
	<p>Iron Pillar HDW20254</p> <p>1" L x 2 1/8" W</p> <p><i>Works best with 7/8" or larger rod diameter or square</i></p>	<ul style="list-style-type: none"> • Bronze - 66 • Vintage - 84 • Cast Iron - 818 • Antique Gold - 418 • Rustic - 624 • Aged Silver - 106 	2
	<p>Iron Capital HDW20253</p> <p>1 7/8" L x 2 1/2" W</p> <p><i>Works best with 1" or larger rod diameter or square</i></p>	<ul style="list-style-type: none"> • Bronze - 66 • Vintage - 84 • Cast Iron - 818 • Antique Gold - 418 • Rustic - 624 • Aged Silver - 106 	2

NEW! Rustic Iron Collection can be specially treated for outdoor use with an upcharge.
(Rustic Iron Traversing cannot be treated for outdoor use.)

Custom

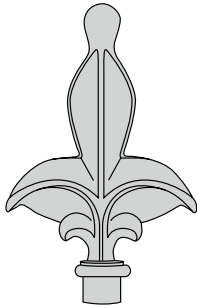

	Styles / Specifications	Available Finishes	Catalog Pg.
	<p>Pinion HDW20207</p> <p>3" L x 1 5/8" W</p> <p><i>Works best with 7/8" or larger rod diameter or square</i></p>	<ul style="list-style-type: none"> • Bronze - 66 • Vintage - 84 • Cast Iron - 818 • Antique Gold - 418 • Rustic - 624 • Aged Silver - 106 	2
	<p>Iron Spade HDW20209</p> <p>3 1/2" L x 2" W</p> <p><i>Works best with 7/8" or larger rod diameter or square</i></p>	<ul style="list-style-type: none"> • Bronze - 66 • Vintage - 84 • Cast Iron - 818 • Antique Gold - 418 • Rustic - 624 • Aged Silver - 106 	2
	<p>Ponderosa HDW20206</p> <p>5 3/8" L x 2 5/8" W</p> <p><i>Works best with 1" or larger rod diameter or square</i></p>	<ul style="list-style-type: none"> • Bronze - 66 • Vintage - 84 • Cast Iron - 818 • Antique Gold - 418 • Rustic - 624 • Aged Silver - 106 	2
	<p>Iron Spear HDW20202</p> <p>6" L x 3 1/8" W</p> <p><i>Works best with 7/8" or larger rod diameter or square</i></p>	<ul style="list-style-type: none"> • Bronze - 66 • Vintage - 84 • Cast Iron - 818 • Antique Gold - 418 • Rustic - 624 • Aged Silver - 106 	2

NEW! Rustic Iron Collection can be specially treated for outdoor use with an upcharge.
(Rustic Iron Traversing cannot be treated for outdoor use.)

	Styles / Specifications	Available Finishes	Catalog Pg.
 <p>Length</p> <p>Width</p>	<p>Iron Fleur HDW20208</p> <p>6 1/4" L x 4 1/4" W</p> <p><i>Works best with 7/8" or larger rod diameter or square</i></p>	<ul style="list-style-type: none"> • Bronze - 66 • Vintage - 84 • Cast Iron - 818 • Antique Gold - 418 • Rustic - 624 • Aged Silver - 106 	2
 <p>Dia.</p>	<p>Solid Hammered Iron Rod HDW20229</p> <p>3/4" Dia.</p> <p><i>Maximum length per rod is 106". Rod will automatically be spliced thereafter.</i></p>	<ul style="list-style-type: none"> • Bronze - 66 • Vintage - 84 • Cast Iron - 818 • Antique Gold - 418 • Rustic - 624 • Aged Silver - 106 	3
 <p>Dia.</p>	<p>Hollow Iron Rod - 3/4" HDW20228</p> <p>3/4" Dia.</p> <p><i>Maximum length per rod is 106". Rod will automatically be spliced thereafter.</i></p>	<ul style="list-style-type: none"> • Bronze - 66 • Vintage - 84 • Cast Iron - 818 • Antique Gold - 418 • Rustic - 624 • Aged Silver - 106 	3
 <p>Dia.</p>	<p>Solid Iron Rod - 7/8" HDW20230</p> <p>7/8" Dia.</p> <p><i>Maximum length per rod is 106". Rod will automatically be spliced thereafter.</i></p>	<ul style="list-style-type: none"> • Bronze - 66 • Vintage - 84 • Cast Iron - 818 • Antique Gold - 418 • Rustic - 624 • Aged Silver - 106 	3

NEW! Rustic Iron Collection can be specially treated for outdoor use with an upcharge.
(Rustic Iron Traversing cannot be treated for outdoor use.)

Custom

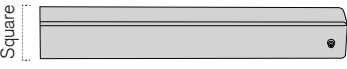
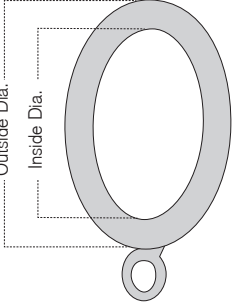
	Styles / Specifications	Available Finishes	Catalog Pg.
	<p>Hollow Iron Rod - 1" HDW20226</p> <p>1" Dia.</p> <p><i>Maximum length per rod is 106". Rod will automatically be spliced thereafter.</i></p>	<ul style="list-style-type: none"> • Bronze - 66 • Vintage - 84 • Cast Iron - 818 • Antique Gold - 418 • Rustic - 624 • Aged Silver - 106 	3
	<p>Hollow Iron Rod - 1 1/2" HDW20227</p> <p>1 1/2" Dia.</p> <p><i>Maximum length per rod is 106". Rod will automatically be spliced thereafter.</i></p>	<ul style="list-style-type: none"> • Bronze - 66 • Vintage - 84 • Cast Iron - 818 • Antique Gold - 418 • Rustic - 624 • Aged Silver - 106 	3
	<p>Square Iron Rod - 1" HDW20231</p> <p>1" Square</p> <p><i>Maximum length per rod is 106". Rod will automatically be spliced thereafter.</i></p>	<ul style="list-style-type: none"> • Bronze - 66 • Vintage - 84 • Cast Iron - 818 • Antique Gold - 418 • Rustic - 624 • Aged Silver - 106 	3
	<p>Iron Ring - 3/4" HDW20157</p> <p>1 1/4" Inside Dia. 1 3/4" Outside Dia. 1/4" Thick</p> <p><i>Ring size refers to coordinating rod diameter.</i></p>	<ul style="list-style-type: none"> • Bronze - 66 • Vintage - 84 • Cast Iron - 818 • Antique Gold - 418 • Rustic - 624 • Aged Silver - 106 	4

NEW! Rustic Iron Collection can be specially treated for outdoor use with an upcharge.
(Rustic Iron Traversing cannot be treated for outdoor use.)

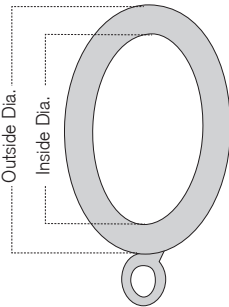
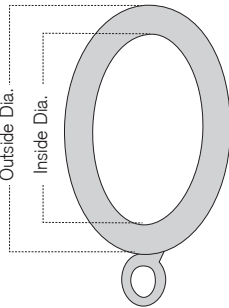
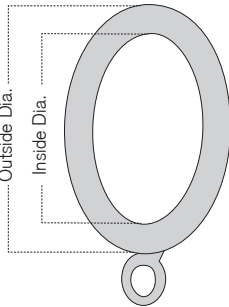
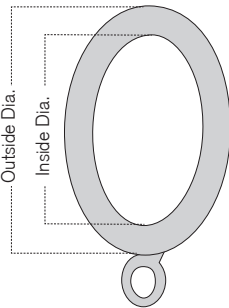
	Styles / Specifications	Available Finishes	Catalog Pg.
	<p>Iron Ring - 7/8" HDW20158</p> <p>1 1/2" Inside Dia. 2" Outside Dia. 1/4" Thick</p> <p><i>Ring size refers to coordinating rod diameter.</i></p>	<ul style="list-style-type: none"> • Bronze - 66 • Vintage - 84 • Cast Iron - 818 • Antique Gold - 418 • Rustic - 624 • Aged Silver - 106 	4
	<p>Iron Ring - 1" HDW20159</p> <p>1 1/2" Inside Dia. 2" Outside Dia. 1/4" Thick</p> <p><i>Ring size refers to coordinating rod diameter.</i></p>	<ul style="list-style-type: none"> • Bronze - 66 • Vintage - 84 • Cast Iron - 818 • Antique Gold - 418 • Rustic - 624 • Aged Silver - 106 	4
	<p>Iron Ring - 1 1/2" HDW20152</p> <p>2" Inside Dia. 2 1/2" Outside Dia. 1/4" Thick</p> <p><i>Ring size refers to coordinating rod diameter.</i></p>	<ul style="list-style-type: none"> • Bronze - 66 • Vintage - 84 • Cast Iron - 818 • Antique Gold - 418 • Rustic - 624 • Aged Silver - 106 	4
	<p>Iron Ring - 1 1/2" HDW20160</p> <p>1 7/8" Inside Dia. 2 5/8" Outside Dia. 3/8" Thick</p> <p><i>Ring size refers to coordinating rod diameter.</i></p>	<ul style="list-style-type: none"> • Bronze - 66 • Vintage - 84 • Cast Iron - 818 • Antique Gold - 418 • Rustic - 624 • Aged Silver - 106 	4

NEW! Rustic Iron Collection can be specially treated for outdoor use with an upcharge.
(Rustic Iron Traversing cannot be treated for outdoor use.)

Custom

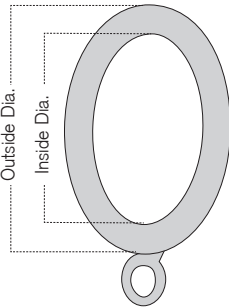
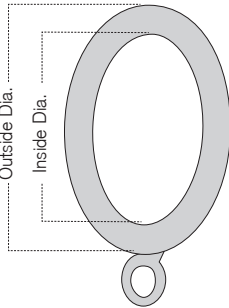
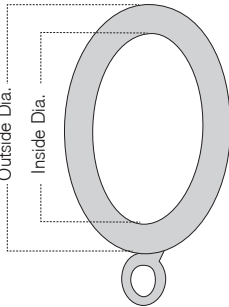
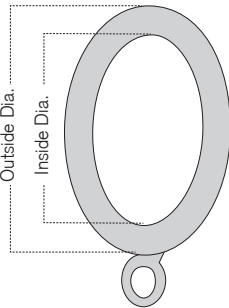

	Styles / Specifications	Available Finishes	Catalog Pg.
	<p>Forged Hammered Iron Ring - 3/4" HDW20162</p> <p>1 1/4" Inside Dia. 1 3/4" Outside Dia. 1/4" Thick</p> <p><i>Ring size refers to coordinating rod diameter.</i></p>	<ul style="list-style-type: none"> • Bronze - 66 • Vintage - 84 • Cast Iron - 818 • Antique Gold - 418 • Rustic - 624 • Aged Silver - 106 	4
	<p>Forged Hammered Iron Ring - 7/8" HDW20163</p> <p>1 1/2" Inside Dia. 2" Outside Dia. 1/4" Thick</p> <p><i>Ring size refers to coordinating rod diameter.</i></p>	<ul style="list-style-type: none"> • Bronze - 66 • Vintage - 84 • Cast Iron - 818 • Antique Gold - 418 • Rustic - 624 • Aged Silver - 106 	4
	<p>Forged Hammered Iron Ring - 1" HDW20164</p> <p>1 1/2" Inside Dia. 2" Outside Dia. 1/4" Thick</p> <p><i>Ring size refers to coordinating rod diameter.</i></p>	<ul style="list-style-type: none"> • Bronze - 66 • Vintage - 84 • Cast Iron - 818 • Antique Gold - 418 • Rustic - 624 • Aged Silver - 106 	4
	<p>Forged Hammered Iron Ring - 1 1/2" HDW20165</p> <p>2" Inside Dia. 2 1/2" Outside Dia. 1/4" Thick</p> <p><i>Ring size refers to coordinating rod diameter.</i></p>	<ul style="list-style-type: none"> • Bronze - 66 • Vintage - 84 • Cast Iron - 818 • Antique Gold - 418 • Rustic - 624 • Aged Silver - 106 	4

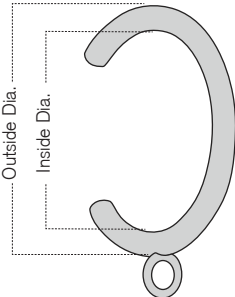
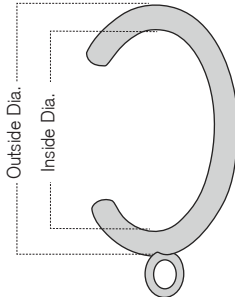
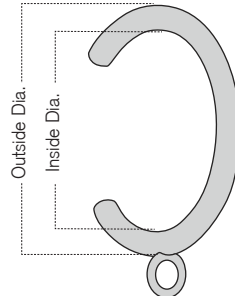
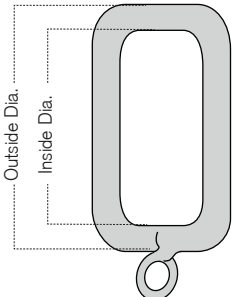
NEW! Rustic Iron Collection can be specially treated for outdoor use with an upcharge.
(Rustic Iron Traversing cannot be treated for outdoor use.)

	Styles / Specifications	Available Finishes	Catalog Pg.
	<p>Iron Passing Ring - 3/4" HDW20166</p> <p>1 1/4" Inside Dia. 1 3/4" Outside Dia.</p> <p><i>Ring size refers to coordinating rod diameter.</i></p>	<ul style="list-style-type: none"> • Bronze - 66 • Vintage - 84 • Cast Iron - 818 • Antique Gold - 418 • Rustic - 624 • Aged Silver - 106 	4
	<p>Iron Passing Ring - 1" HDW20167</p> <p>1 1/2" Inside Dia. 2" Outside Dia.</p> <p><i>Ring size refers to coordinating rod diameter.</i></p>	<ul style="list-style-type: none"> • Bronze - 66 • Vintage - 84 • Cast Iron - 818 • Antique Gold - 418 • Rustic - 624 • Aged Silver - 106 	4
	<p>Iron Passing Ring - 1 1/2" HDW20168</p> <p>2" Inside Dia. 2 1/2" Outside Dia.</p> <p><i>Ring size refers to coordinating rod diameter.</i></p>	<ul style="list-style-type: none"> • Bronze - 66 • Vintage - 84 • Cast Iron - 818 • Antique Gold - 418 • Rustic - 624 • Aged Silver - 106 	4
	<p>Iron Square Ring - 1" HDW20161</p> <p>1 1/2" L x 2" W Inside 2 1/2" L x 2" W Outside</p> <p><i>Designed to coordinate with iron square rod</i></p>	<ul style="list-style-type: none"> • Bronze - 66 • Vintage - 84 • Cast Iron - 818 • Antique Gold - 418 • Rustic - 624 • Aged Silver - 106 	4

NEW! Rustic Iron Collection can be specially treated for outdoor use with an upcharge.
(Rustic Iron Traversing cannot be treated for outdoor use.)

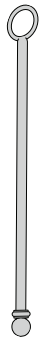
Custom

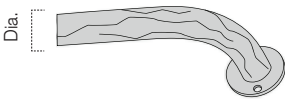
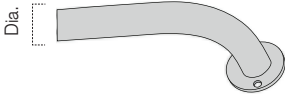
	Styles / Specifications	Available Finishes	Catalog Pg.
 <p>..... Dia.</p>	<p>Iron Baton Round HDW20175</p> <p>Up to 48" L 1/2" Dia. Rod</p> <p><i>Must specify if clip is preferred over ring. Specify baton finished length of rod, up to 48"</i></p>	<ul style="list-style-type: none"> • Bronze - 66 • Vintage - 84 • Cast Iron - 818 • Antique Gold - 418 • Rustic - 624 • Aged Silver - 106 	4
 <p>..... Dia.</p>	<p>Iron Baton Square HDW20176</p> <p>Up to 48" L 1/2" Square Rod</p> <p><i>Must specify if clip is preferred over ring. Specify baton finished length of rod, up to 48"</i></p>	<ul style="list-style-type: none"> • Bronze - 66 • Vintage - 84 • Cast Iron - 818 • Antique Gold - 418 • Rustic - 624 • Aged Silver - 106 	4
 <p>Dia.</p>	<p>Rod with Return - 3/4" (Solid) HDW20238</p> <p>3/4" Dia.</p> <p><i>Wall mount sockets included.</i></p>	<ul style="list-style-type: none"> • Bronze - 66 • Vintage - 84 • Cast Iron - 818 • Antique Gold - 418 • Rustic - 624 • Aged Silver - 106 	4
 <p>Dia.</p>	<p>Rod with Return - 7/8" (Solid) HDW20239</p> <p>7/8" Dia.</p> <p><i>Wall mount sockets included.</i></p>	<ul style="list-style-type: none"> • Bronze - 66 • Vintage - 84 • Cast Iron - 818 • Antique Gold - 418 • Rustic - 624 • Aged Silver - 106 	4

NEW! Rustic Iron Collection can be specially treated for outdoor use with an upcharge.
(Rustic Iron Traversing cannot be treated for outdoor use.)

	Styles / Specifications	Available Finishes	Catalog Pg.
	<p>Rod with Return - 3/4" (Hollow) HDW20236</p> <p>3/4" Dia.</p> <p><i>Wall mount sockets included.</i></p>	<ul style="list-style-type: none"> • Bronze - 66 • Vintage - 84 • Cast Iron - 818 • Antique Gold - 418 • Rustic - 624 • Aged Silver - 106 	4
	<p>Rod with Return - 1" (Hollow) HDW20237</p> <p>1" Dia.</p> <p><i>Wall mount sockets included.</i></p>	<ul style="list-style-type: none"> • Bronze - 66 • Vintage - 84 • Cast Iron - 818 • Antique Gold - 418 • Rustic - 624 • Aged Silver - 106 	4
	<p>Rod with Return - 1 1/2" (Hollow) HDW20235</p> <p>1 1/2" Dia.</p> <p><i>Wall mount sockets included.</i></p>	<ul style="list-style-type: none"> • Bronze - 66 • Vintage - 84 • Cast Iron - 818 • Antique Gold - 418 • Rustic - 624 • Aged Silver - 106 	4
	<p>Square Rod with Return - 1" HDW20240</p> <p>1" Square</p> <p><i>Wall mount sockets included.</i></p>	<ul style="list-style-type: none"> • Bronze - 66 • Vintage - 84 • Cast Iron - 818 • Antique Gold - 418 • Rustic - 624 • Aged Silver - 106 	4

NEW! Rustic Iron Collection can be specially treated for outdoor use with an upcharge.
(Rustic Iron Traversing cannot be treated for outdoor use.)

Custom

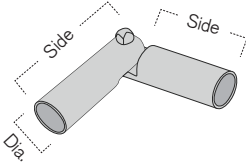
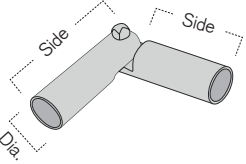
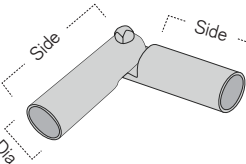
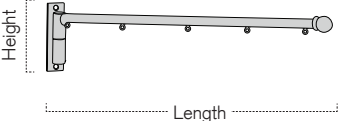
	Styles / Specifications	Available Finishes	Catalog Pg.
	<p>Adjustable Elbow - 3/4" HDW20172</p> <p>3" L each side 3/4" Dia.</p>	<ul style="list-style-type: none"> • Bronze - 66 • Vintage - 84 • Cast Iron - 818 • Antique Gold - 418 • Rustic - 624 • Aged Silver - 106 	4
	<p>Adjustable Elbow - 1" HDW20173</p> <p>3" L each side 1" Dia.</p>	<ul style="list-style-type: none"> • Bronze - 66 • Vintage - 84 • Cast Iron - 818 • Antique Gold - 418 • Rustic - 624 • Aged Silver - 106 	4
	<p>Adjustable Elbow - 1 1/2" HDW20174</p> <p>3" L each side 1 1/2" Dia.</p>	<ul style="list-style-type: none"> • Bronze - 66 • Vintage - 84 • Cast Iron - 818 • Antique Gold - 418 • Rustic - 624 • Aged Silver - 106 	4
	<p>Swing Arm Round HDW20181</p> <p>36" L 1/2" Dia. Rod 4" H Back Plate</p> <p><i>Automatically comes with eyelet. Please specify if no eyelets are required.</i></p>	<ul style="list-style-type: none"> • Bronze - 66 • Vintage - 84 • Cast Iron - 818 • Antique Gold - 418 • Rustic - 624 • Aged Silver - 106 	4

NEW! Rustic Iron Collection can be specially treated for outdoor use with an upcharge.
(Rustic Iron Traversing cannot be treated for outdoor use.)

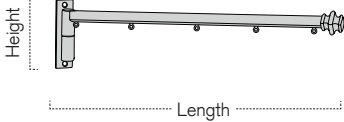
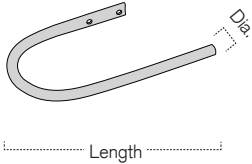
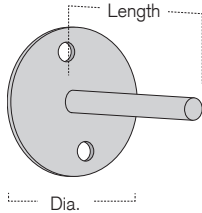
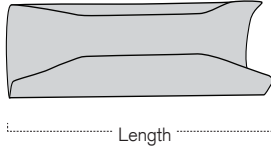
	Styles / Specifications	Available Finishes	Catalog Pg.
	<p>Swing Arm Square - 1/2" Dia. HDW20182</p> <p>36" L 1/2" Square Rod 4" H Back Plate</p> <p><i>Automatically comes with eyelet. Please specify if no eyelets are required.</i></p>	<ul style="list-style-type: none"> • Bronze - 66 • Vintage - 84 • Cast Iron - 818 • Antique Gold - 418 • Rustic - 624 • Aged Silver - 106 	4
	<p>U-Shaped Tieback HDW20177</p> <p>8 1/2" L 1/2" Dia. 6 1/2" Back Plate</p> <p><i>Designed for decorative finial to be added. Select and order separately any finial designs from the Rustic Irons to complete the tieback unit.</i></p>	<ul style="list-style-type: none"> • Bronze - 66 • Vintage - 84 • Cast Iron - 818 • Antique Gold - 418 • Rustic - 624 • Aged Silver - 106 	4
	<p>Tieback HDW20301</p> <p>2" Dia. 2 3/4" L</p> <p><i>Designed for decorative finial to be added. Select and order separately any finial designs from the Rustic Irons to complete the tieback unit.</i></p>	<ul style="list-style-type: none"> • Bronze - 66 • Vintage - 84 • Cast Iron - 818 • Antique Gold - 418 • Rustic - 624 • Aged Silver - 106 	4
	<p>Connector/Splice - 3/4" HDW20232</p> <p>4 1/2" L</p> <p><i>Used to join two spliced rods together as well as add support at joint. Connector is not visible when installed.</i></p>	<ul style="list-style-type: none"> • Bronze - 66 • Vintage - 84 • Cast Iron - 818 • Antique Gold - 418 • Rustic - 624 • Aged Silver - 106 	4

NEW! Rustic Iron Collection can be specially treated for outdoor use with an upcharge.
(Rustic Iron Traversing cannot be treated for outdoor use.)

Custom

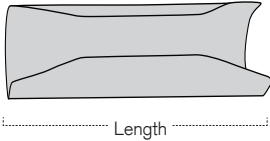
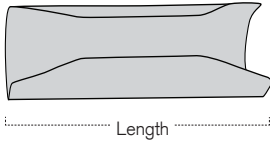
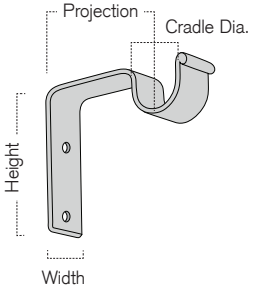
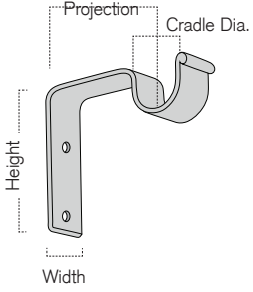
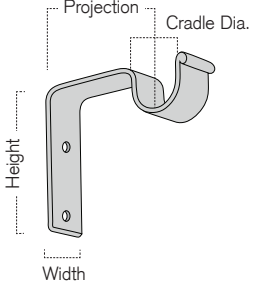
	Styles / Specifications	Available Finishes	Catalog Pg.
	<p>Connector/Splice - 1" HDW20233</p> <p>4 3/4" L</p> <p><i>Used to join two spliced rods together as well as add support at joint. Connector is not visible when installed.</i></p>	<ul style="list-style-type: none"> • Bronze - 66 • Vintage - 84 • Cast Iron - 818 • Antique Gold - 418 • Rustic - 624 • Aged Silver - 106 	4
	<p>Connector/Splice - 1 1/2" HDW20234</p> <p>5 7/8" L</p> <p><i>Used to join two spliced rods together as well as add support at joint. Connector is not visible when installed.</i></p>	<ul style="list-style-type: none"> • Bronze - 66 • Vintage - 84 • Cast Iron - 818 • Antique Gold - 418 • Rustic - 624 • Aged Silver - 106 	4
	<p>Single Bracket HDW20183</p> <p>3 1/4" H x 1" W 3" Projection Designed for 3/4" Dia. Rod</p> <p><i>Primarily used as a support bracket. Size refers to the cradle diameter that coordinates with matching rod diameter.</i></p>	<ul style="list-style-type: none"> • Bronze - 66 • Vintage - 84 • Cast Iron - 818 • Antique Gold - 418 • Rustic - 624 • Aged Silver - 106 	5
	<p>Single Bracket HDW20184</p> <p>3 1/4" H x 1" W 3" Projection Designed for 7/8" Dia. Rod</p> <p><i>Bracket for 7/8" size is used for both support and end bracket. Size refers to the cradle diameter that coordinates with matching rod diameter.</i></p>	<ul style="list-style-type: none"> • Bronze - 66 • Vintage - 84 • Cast Iron - 818 • Antique Gold - 418 • Rustic - 624 • Aged Silver - 106 	5
	<p>Single Bracket HDW20185</p> <p>3 1/4" H x 1" W 3" Projection Designed for 1" Dia. Rod</p> <p><i>Primarily used as a support bracket. Size refers to the cradle diameter that coordinates with matching rod diameter.</i></p>	<ul style="list-style-type: none"> • Bronze - 66 • Vintage - 84 • Cast Iron - 818 • Antique Gold - 418 • Rustic - 624 • Aged Silver - 106 	5

NEW! Rustic Iron Collection can be specially treated for outdoor use with an upcharge.
(Rustic Iron Traversing cannot be treated for outdoor use.)

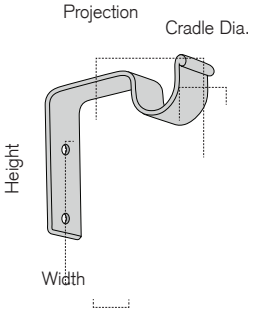
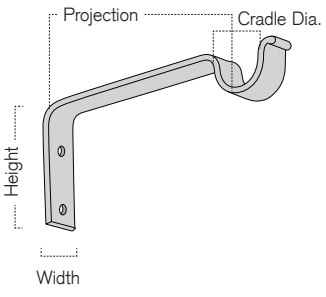
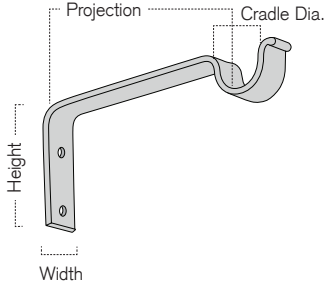
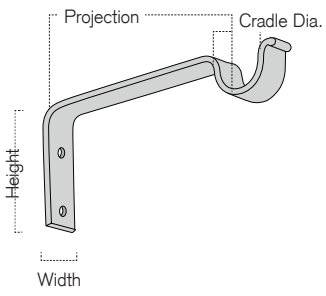
	Styles / Specifications	Available Finishes	Catalog Pg.
	<p>Single Bracket HDW20186</p> <p>3 1/4" H x 1" W 3" Projection Designed for 1 1/2" Dia. Rod</p> <p><i>Primarily used as a support bracket. Size refers to the cradle diameter that coordinates with matching rod diameter.</i></p>	<ul style="list-style-type: none"> • Bronze - 66 • Vintage - 84 • Cast Iron - 818 • Antique Gold - 418 • Rustic - 624 • Aged Silver - 106 	5
	<p>Single Bracket HDW20195</p> <p>3 1/4" H x 1" W 6" Projection Designed for 3/4" Dia. Rod</p> <p><i>Primarily used as a support bracket. Size refers to the cradle diameter that coordinates with matching rod diameter.</i></p>	<ul style="list-style-type: none"> • Bronze - 66 • Vintage - 84 • Cast Iron - 818 • Antique Gold - 418 • Rustic - 624 • Aged Silver - 106 	5
	<p>Single Bracket HDW20196</p> <p>3 1/4" H x 1" W 6" Projection Designed for 7/8" Dia. Rod</p> <p><i>Bracket for 7/8" size is used for both support and end bracket. Size refers to the cradle diameter that coordinates with matching rod diameter.</i></p>	<ul style="list-style-type: none"> • Bronze - 66 • Vintage - 84 • Cast Iron - 818 • Antique Gold - 418 • Rustic - 624 • Aged Silver - 106 	5
	<p>Single Bracket HDW20197</p> <p>3 1/4" H x 1" W 6" Projection Designed for 1" Dia. Rod</p> <p><i>Primarily used as a support bracket. Size refers to the cradle diameter that coordinates with matching rod diameter.</i></p>	<ul style="list-style-type: none"> • Bronze - 66 • Vintage - 84 • Cast Iron - 818 • Antique Gold - 418 • Rustic - 624 • Aged Silver - 106 	5

NEW! Rustic Iron Collection can be specially treated for outdoor use with an upcharge.
(Rustic Iron Traversing cannot be treated for outdoor use.)

Custom

	Styles / Specifications	Available Finishes	Catalog Pg.
	<p>Single Bracket HDW20198</p> <p>3 1/4" H x 1" W 6" Projection Designed for 1 1/2" Dia. Rod</p> <p><i>Primarily used as a support bracket. Size refers to the cradle diameter that coordinates with matching rod diameter</i></p>	<ul style="list-style-type: none"> • Bronze - 66 • Vintage - 84 • Cast Iron - 818 • Antique Gold - 418 • Rustic - 624 • Aged Silver - 106 	5
	<p>Double Bracket HDW20187</p> <p>4" H x 1" W 3" and 6" Projection Designed for 3/4" Dia. Rod</p> <p><i>Primarily used as a support bracket. Size refers to the cradle diameter that coordinates with matching rod diameter</i></p>	<ul style="list-style-type: none"> • Bronze - 66 • Vintage - 84 • Cast Iron - 818 • Antique Gold - 418 • Rustic - 624 • Aged Silver - 106 	5
	<p>Double Bracket HDW20188</p> <p>4" H x 1" W 3" and 6" Projection Designed for 7/8" Dia. Rod</p> <p><i>Primarily used as a support bracket. Size refers to the cradle diameter that coordinates with matching rod diameter</i></p>	<ul style="list-style-type: none"> • Bronze - 66 • Vintage - 84 • Cast Iron - 818 • Antique Gold - 418 • Rustic - 624 • Aged Silver - 106 	5
	<p>Double Bracket HDW20189</p> <p>4" H x 1" W 3" and 6" Projection Designed for 1" Dia. Rod</p> <p><i>Primarily used as a support bracket. Size refers to the cradle diameter that coordinates with matching rod diameter</i></p>	<ul style="list-style-type: none"> • Bronze - 66 • Vintage - 84 • Cast Iron - 818 • Antique Gold - 418 • Rustic - 624 • Aged Silver - 106 	5

NEW! Rustic Iron Collection can be specially treated for outdoor use with an upcharge.
(Rustic Iron Traversing cannot be treated for outdoor use.)

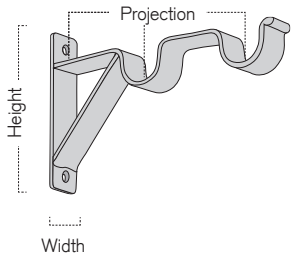
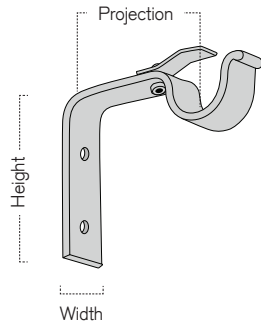
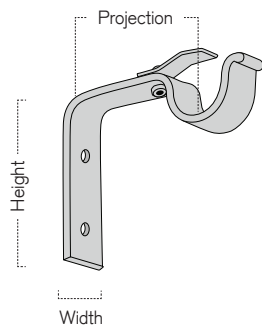
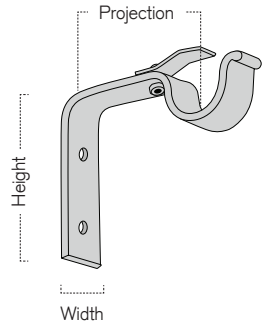
	Styles / Specifications	Available Finishes	Catalog Pg.
	<p>Double Bracket HDW20190</p> <p>4" H x 1" W 3" and 6" Projection Designed for 1 1/2" Dia. Rod</p> <p><i>Primarily used as a support bracket. Size refers to the cradle diameter that coordinates with matching rod diameter</i></p>	<ul style="list-style-type: none"> • Bronze - 66 • Vintage - 84 • Cast Iron - 818 • Antique Gold - 418 • Rustic - 624 • Aged Silver - 106 	5
	<p>Single End Bracket HDW20150</p> <p>3 1/4" H x 1" W 3" Projection Designed for 3/4" Dia. Rod</p>	<ul style="list-style-type: none"> • Bronze - 66 • Vintage - 84 • Cast Iron - 818 • Antique Gold - 418 • Rustic - 624 • Aged Silver - 106 	5
	<p>Single End Bracket HDW20151</p> <p>3 1/4" H x 1" W 3" Projection Designed for 1" Dia. Rod</p>	<ul style="list-style-type: none"> • Bronze - 66 • Vintage - 84 • Cast Iron - 818 • Antique Gold - 418 • Rustic - 624 • Aged Silver - 106 	5
	<p>Single End Bracket HDW20153</p> <p>3 1/4" H x 1" W 3" Projection Designed for 1 1/2" Dia. Rod</p>	<ul style="list-style-type: none"> • Bronze - 66 • Vintage - 84 • Cast Iron - 818 • Antique Gold - 418 • Rustic - 624 • Aged Silver - 106 	5

NEW! Rustic Iron Collection can be specially treated for outdoor use with an upcharge.
(Rustic Iron Traversing cannot be treated for outdoor use.)

Custom

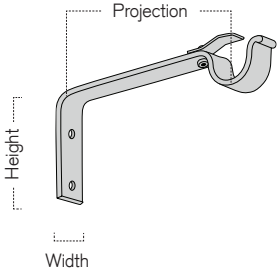
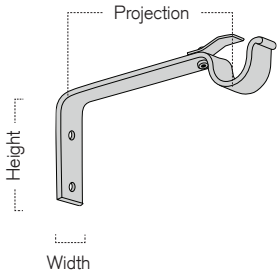
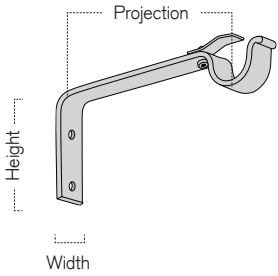
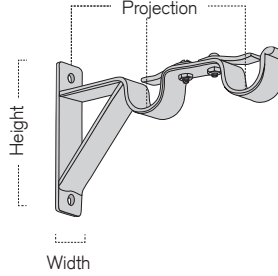
	Styles / Specifications	Available Finishes	Catalog Pg.
	<p>Single End Bracket HDW20154</p> <p>3 1/4" H x 1" W 6" Projection Designed for 3/4" Dia. Rod</p>	<ul style="list-style-type: none"> • Bronze - 66 • Vintage - 84 • Cast Iron - 818 • Antique Gold - 418 • Rustic - 624 • Aged Silver - 106 	5
	<p>Single End Bracket HDW20155</p> <p>3 1/4" H x 1" W 6" Projection Designed for 1" Dia. Rod</p>	<ul style="list-style-type: none"> • Bronze - 66 • Vintage - 84 • Cast Iron - 818 • Antique Gold - 418 • Rustic - 624 • Aged Silver - 106 	5
	<p>Single End Bracket HDW20156</p> <p>3 1/4" H x 1" W 6" Projection Designed for 1 1/2" Dia. Rod</p>	<ul style="list-style-type: none"> • Bronze - 66 • Vintage - 84 • Cast Iron - 818 • Antique Gold - 418 • Rustic - 624 • Aged Silver - 106 	5
	<p>Double End Bracket HDW20178</p> <p>4" H x 1" W 3" and 6" Projection Designed for 3/4" Dia. Rod</p>	<ul style="list-style-type: none"> • Bronze - 66 • Vintage - 84 • Cast Iron - 818 • Antique Gold - 418 • Rustic - 624 • Aged Silver - 106 	5

NEW! Rustic Iron Collection can be specially treated for outdoor use with an upcharge.
(Rustic Iron Traversing cannot be treated for outdoor use.)

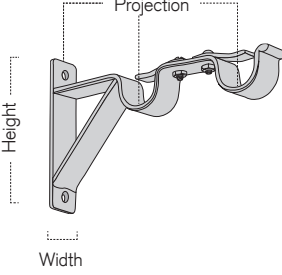
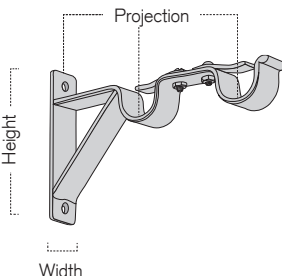
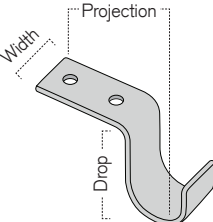
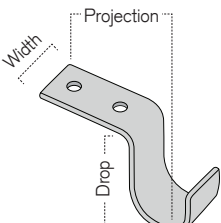
	Styles / Specifications	Available Finishes	Catalog Pg.
	<p>Double End Bracket HDW20179</p> <p>4" H x 1" W 3" and 6" Projection Designed for 1" Dia. Rod</p>	<ul style="list-style-type: none"> • Bronze - 66 • Vintage - 84 • Cast Iron - 818 • Antique Gold - 418 • Rustic - 624 • Aged Silver - 106 	5
	<p>Double End Bracket HDW20180</p> <p>4" H x 1" W 3" and 6" Projection Designed for 1 1/2" Dia. Rod</p>	<ul style="list-style-type: none"> • Bronze - 66 • Vintage - 84 • Cast Iron - 818 • Antique Gold - 418 • Rustic - 624 • Aged Silver - 106 	5
	<p>Single Ceiling Mount Bracket HDW20191</p> <p>1" W x 2" Drop 3" Projection Designed for 3/4" Dia. Rod</p>	<ul style="list-style-type: none"> • Bronze - 66 • Vintage - 84 • Cast Iron - 818 • Antique Gold - 418 • Rustic - 624 • Aged Silver - 106 	5
	<p>Single Ceiling Mount Bracket HDW20192</p> <p>1" W x 2" Drop 3" Projection Designed for 7/8" Dia. Rod</p>	<ul style="list-style-type: none"> • Bronze - 66 • Vintage - 84 • Cast Iron - 818 • Antique Gold - 418 • Rustic - 624 • Aged Silver - 106 	5

NEW! Rustic Iron Collection can be specially treated for outdoor use with an upcharge.
(Rustic Iron Traversing cannot be treated for outdoor use.)

Custom

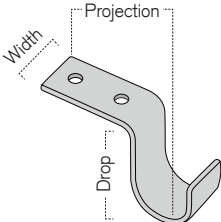
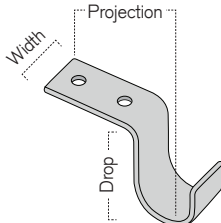
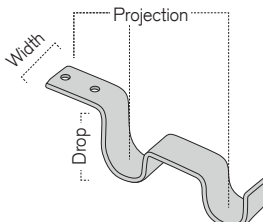
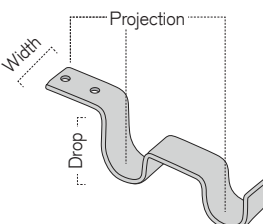
	Styles / Specifications	Available Finishes	Catalog Pg.
	<p>Single Ceiling Mount Bracket HDW20193</p> <p>1" W x 2" Drop 3" Projection Designed for 1" Dia. Rod</p>	<ul style="list-style-type: none"> • Bronze - 66 • Vintage - 84 • Cast Iron - 818 • Antique Gold - 418 • Rustic - 624 • Aged Silver - 106 	5
	<p>Single Ceiling Mount Bracket HDW20194</p> <p>1" W x 2" Drop 3" Projection Designed for 1 1/2" Dia. Rod</p>	<ul style="list-style-type: none"> • Bronze - 66 • Vintage - 84 • Cast Iron - 818 • Antique Gold - 418 • Rustic - 624 • Aged Silver - 106 	5
	<p>Double Ceiling Mount Bracket HDW20222</p> <p>1" W x 2" Drop 3" and 6" Projection Designed for 3/4" Dia. Rod</p>	<ul style="list-style-type: none"> • Bronze - 66 • Vintage - 84 • Cast Iron - 818 • Antique Gold - 418 • Rustic - 624 • Aged Silver - 106 	5
	<p>Double Ceiling Mount Bracket HDW20223</p> <p>1" W x 2" Drop 3" and 6" Projection Designed for 7/8" Dia. Rod</p>	<ul style="list-style-type: none"> • Bronze - 66 • Vintage - 84 • Cast Iron - 818 • Antique Gold - 418 • Rustic - 624 • Aged Silver - 106 	5

NEW! Rustic Iron Collection can be specially treated for outdoor use with an upcharge.
(Rustic Iron Traversing cannot be treated for outdoor use.)

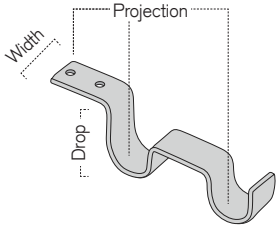
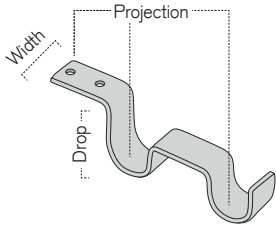
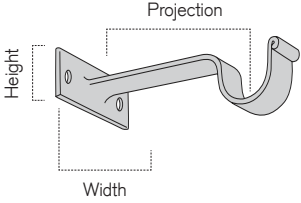
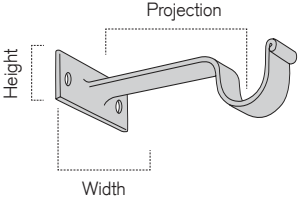
	Styles / Specifications	Available Finishes	Catalog Pg.
	<p>Double Ceiling Mount Bracket HDW20224</p> <p>1" W x 2" Drop 3" and 6" Projection Designed for 1" Dia. Rod</p>	<ul style="list-style-type: none"> • Bronze - 66 • Vintage - 84 • Cast Iron - 818 • Antique Gold - 418 • Rustic - 624 • Aged Silver - 106 	5
	<p>Double Ceiling Mount Bracket HDW20225</p> <p>1" W x 2" Drop 3" and 6" Projection Designed for 1 1/2" Dia. Rod</p>	<ul style="list-style-type: none"> • Bronze - 66 • Vintage - 84 • Cast Iron - 818 • Antique Gold - 418 • Rustic - 624 • Aged Silver - 106 	5
	<p>NEW! Horizontal Support Bracket HDW20344</p> <p>Back Plate 3" W x 1" H 3" Projection Designed for 3/4" Dia. Rod</p>	<ul style="list-style-type: none"> • Bronze - 66 • Vintage - 84 • Cast Iron - 818 • Antique Gold - 418 • Rustic - 624 • Aged Silver - 106 	5
	<p>NEW! Horizontal Support Bracket HDW20345</p> <p>Back Plate 3" W x 1" H 3" Projection Designed for 7/8" Dia. Rod</p>	<ul style="list-style-type: none"> • Bronze - 66 • Vintage - 84 • Cast Iron - 818 • Antique Gold - 418 • Rustic - 624 • Aged Silver - 106 	5

NEW! Rustic Iron Collection can be specially treated for outdoor use with an upcharge.
(Rustic Iron Traversing cannot be treated for outdoor use.)

Custom

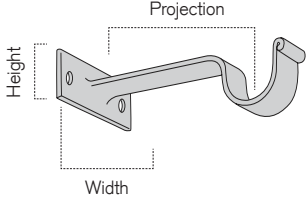
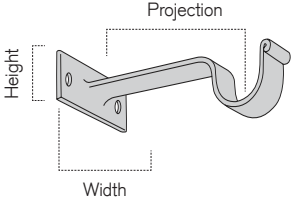
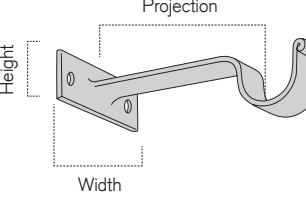
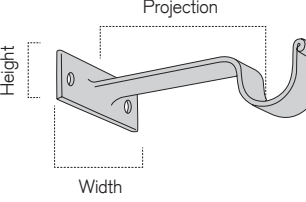
	Styles / Specifications	Available Finishes	Catalog Pg.
	<p>NEW! Horizontal Support Bracket HDW20346</p> <p>Back Plate 3" W x 1" H 3" Projection Designed for 1" Dia. Rod</p>	<ul style="list-style-type: none"> • Bronze - 66 • Vintage - 84 • Cast Iron - 818 • Antique Gold - 418 • Rustic - 624 • Aged Silver - 106 	5
	<p>NEW! Horizontal Support Bracket HDW20347</p> <p>Back Plate 3" W x 1" H 3" Projection Designed for 1 1/2" Dia. Rod</p>	<ul style="list-style-type: none"> • Bronze - 66 • Vintage - 84 • Cast Iron - 818 • Antique Gold - 418 • Rustic - 624 • Aged Silver - 106 	5
	<p>NEW! Horizontal Support Bracket HDW20348</p> <p>Back Plate 3" W x 1" H 6" Projection Designed for 3/4" Dia. Rod</p>	<ul style="list-style-type: none"> • Bronze - 66 • Vintage - 84 • Cast Iron - 818 • Antique Gold - 418 • Rustic - 624 • Aged Silver - 106 	5
	<p>NEW! Horizontal Support Bracket HDW20349</p> <p>Back Plate 3" W x 1" H 6" Projection Designed for 7/8" Dia. Rod</p>	<ul style="list-style-type: none"> • Bronze - 66 • Vintage - 84 • Cast Iron - 818 • Antique Gold - 418 • Rustic - 624 • Aged Silver - 106 	5

NEW! Rustic Iron Collection can be specially treated for outdoor use with an upcharge.
(Rustic Iron Traversing cannot be treated for outdoor use.)

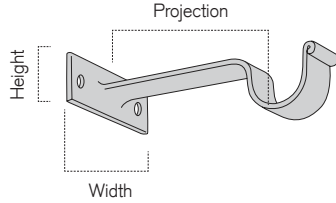
	Styles / Specifications	Available Finishes	Catalog Pg.
	<p>NEW! Horizontal Support Bracket HDW20350</p> <p>Back Plate 3" W x 1" H 6" Projection Designed for 1" Dia. Rod</p>	<ul style="list-style-type: none"> • Bronze - 66 • Vintage - 84 • Cast Iron - 818 • Antique Gold - 418 • Rustic - 624 • Aged Silver - 106 	5
	<p>NEW! Horizontal Support Bracket HDW20351</p> <p>Back Plate 3" W x 1" H 6" Projection Designed for 1 1/2" Dia. Rod</p>	<ul style="list-style-type: none"> • Bronze - 66 • Vintage - 84 • Cast Iron - 818 • Antique Gold - 418 • Rustic - 624 • Aged Silver - 106 	5
	<p>Single Bypass Bracket HDW20214</p> <p>2 1/2" H x 1" W 3" Projection Designed for 3/4" Dia. Rod</p> <p><i>Must use "C" ring with this style bracket.</i></p>	<ul style="list-style-type: none"> • Bronze - 66 • Vintage - 84 • Cast Iron - 818 • Antique Gold - 418 • Rustic - 624 • Aged Silver - 106 	5
	<p>Single Bypass Bracket HDW20215</p> <p>2 1/2" H x 1" W 3" Projection Designed for 1" Dia. Rod</p> <p><i>Must use "C" ring with this style bracket.</i></p>	<ul style="list-style-type: none"> • Bronze - 66 • Vintage - 84 • Cast Iron - 818 • Antique Gold - 418 • Rustic - 624 • Aged Silver - 106 	5

NEW! Rustic Iron Collection can be specially treated for outdoor use with an upcharge.
(Rustic Iron Traversing cannot be treated for outdoor use.)

Custom

	Styles / Specifications	Available Finishes	Catalog Pg.
	<p>Single Bypass Bracket HDW20216</p> <p>2 1/2" H x 1" W 3" Projection Designed for 1 1/2" Dia. Rod</p> <p><i>Must use "C" ring with this style bracket.</i></p>	<ul style="list-style-type: none"> • Bronze - 66 • Vintage - 84 • Cast Iron - 818 • Antique Gold - 418 • Rustic - 624 • Aged Silver - 106 	5
	<p>Single Bypass Bracket HDW20217</p> <p>2 1/2" H x 1" W 6" Projection Designed for 3/4" Dia. Rod</p> <p><i>Must use "C" ring with this style bracket.</i></p>	<ul style="list-style-type: none"> • Bronze - 66 • Vintage - 84 • Cast Iron - 818 • Antique Gold - 418 • Rustic - 624 • Aged Silver - 106 	5
	<p>Single Bypass Bracket HDW20218</p> <p>2 1/2" H x 1" W 6" Projection Designed for 1" Dia. Rod</p> <p><i>Must use "C" ring with this style bracket.</i></p>	<ul style="list-style-type: none"> • Bronze - 66 • Vintage - 84 • Cast Iron - 818 • Antique Gold - 418 • Rustic - 624 • Aged Silver - 106 	5
	<p>Single Bypass Bracket HDW20219</p> <p>2 1/2" H x 1" W 6" Projection Designed for 1 1/2" Dia. Rod</p> <p><i>Must use "C" ring with this style bracket.</i></p>	<ul style="list-style-type: none"> • Bronze - 66 • Vintage - 84 • Cast Iron - 818 • Antique Gold - 418 • Rustic - 624 • Aged Silver - 106 	5

NEW! Rustic Iron Collection can be specially treated for outdoor use with an upcharge.
(Rustic Iron Traversing cannot be treated for outdoor use.)

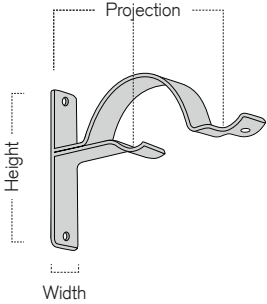
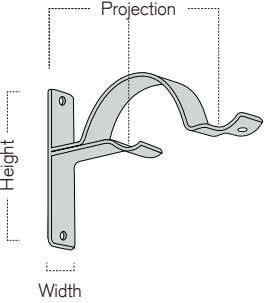
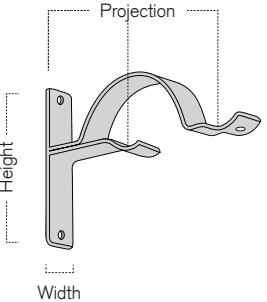
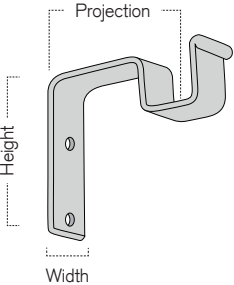
	Styles / Specifications	Available Finishes	Catalog Pg.
	<p>Double Bypass Bracket HDW20147</p> <p>4 1/2" H x 1" W 3" and 6" Projection Designed for 3/4" Dia. Rod</p> <p><i>Must use "C" ring with this style bracket.</i></p>	<ul style="list-style-type: none"> • Bronze - 66 • Vintage - 84 • Cast Iron - 818 • Antique Gold - 418 • Rustic - 624 • Aged Silver - 106 	5
	<p>Double Bypass Bracket HDW20148</p> <p>4 1/2" H x 1" W 3" and 6" Projection Designed for 1" Dia. Rod</p> <p><i>Must use "C" ring with this style bracket.</i></p>	<ul style="list-style-type: none"> • Bronze - 66 • Vintage - 84 • Cast Iron - 818 • Antique Gold - 418 • Rustic - 624 • Aged Silver - 106 	5
	<p>Double Bypass Bracket HDW20149</p> <p>4 1/2" H x 1" W 3" and 6" Projection Designed for 1 1/2" Dia. Rod</p> <p><i>Must use "C" ring with this style bracket.</i></p>	<ul style="list-style-type: none"> • Bronze - 66 • Vintage - 84 • Cast Iron - 818 • Antique Gold - 418 • Rustic - 624 • Aged Silver - 106 	5
	<p>Single Square Bracket HDW20169</p> <p>3 1/4" H x 1" W 3" Projection Designed for 1" Square Rod</p>	<ul style="list-style-type: none"> • Bronze - 66 • Vintage - 84 • Cast Iron - 818 • Antique Gold - 418 • Rustic - 624 • Aged Silver - 106 	5

NEW! Rustic Iron Collection can be specially treated for outdoor use with an upcharge.
(Rustic Iron Traversing cannot be treated for outdoor use.)

Custom

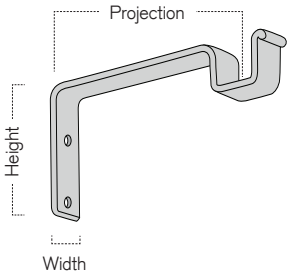
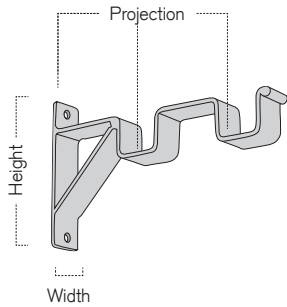
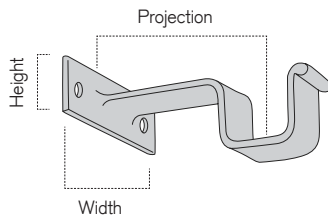
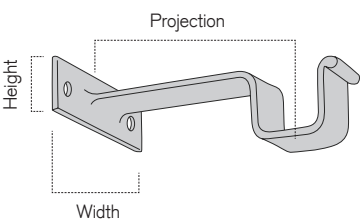
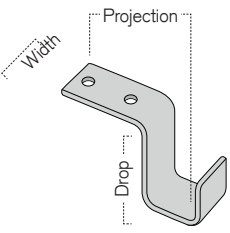
	Styles / Specifications	Available Finishes	Catalog Pg.
	<p>Single Square Bracket HDW20170</p> <p>3 1/4" H x 1" W 6" Projection Designed for 1" Square Rod</p>	<ul style="list-style-type: none"> • Bronze - 66 • Vintage - 84 • Cast Iron - 818 • Antique Gold - 418 • Rustic - 624 • Aged Silver - 106 	5
	<p>Double Square Bracket HDW20171</p> <p>3 1/4" H x 1" W 3" and 6" Projection Designed for 1" Square Rod</p>	<ul style="list-style-type: none"> • Bronze - 66 • Vintage - 84 • Cast Iron - 818 • Antique Gold - 418 • Rustic - 624 • Aged Silver - 106 	5
	<p>NEW! Horizontal Square Support Bracket HDW20352</p> <p>Back Plate 3" W x 1" H 3" Projection</p>	<ul style="list-style-type: none"> • Bronze - 66 • Vintage - 84 • Cast Iron - 818 • Antique Gold - 418 • Rustic - 624 • Aged Silver - 106 	5
	<p>NEW! Horizontal Square Support Bracket HDW20353</p> <p>Back Plate 3" W x 1" 6" Projection</p>	<ul style="list-style-type: none"> • Bronze - 66 • Vintage - 84 • Cast Iron - 818 • Antique Gold - 418 • Rustic - 624 • Aged Silver - 106 	5
	<p>Single Square Ceiling Bracket HDW20220</p> <p>1" W x 2" Drop 3" Projection Designed for 1" Square Rod</p>	<ul style="list-style-type: none"> • Bronze - 66 • Vintage - 84 • Cast Iron - 818 • Antique Gold - 418 • Rustic - 624 • Aged Silver - 106 	5

NEW! Rustic Iron Collection can be specially treated for outdoor use with an upcharge.
(Rustic Iron Traversing cannot be treated for outdoor use.)

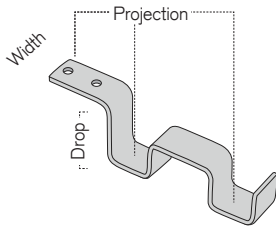
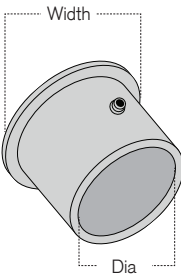
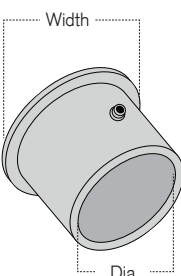
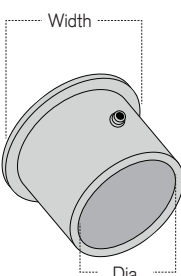
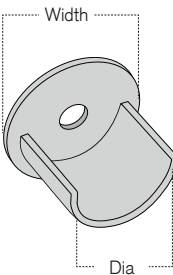
	Styles / Specifications	Available Finishes	Catalog Pg.
	<p>Double Square Ceiling Bracket HDW20221</p> <p>1" W x 2" Drop 3" and 6" Projection Designed for 1" Square Rod</p>	<ul style="list-style-type: none"> • Bronze - 66 • Vintage - 84 • Cast Iron - 818 • Antique Gold - 418 • Rustic - 624 • Aged Silver - 106 	5
	<p>Closed End Socket HDW20244</p> <p>1 1/8" W Designed for 3/4" Dia. Pole</p> <p><i>Socket size refers to coordinating rod diameter. This socket is to be paired with an open ended socket.</i></p>	<ul style="list-style-type: none"> • Bronze - 66 • Vintage - 84 • Cast Iron - 818 • Antique Gold - 418 • Rustic - 624 • Aged Silver - 106 	5
	<p>Closed End Socket HDW20245</p> <p>1 1/8" W Designed for 1" Dia. Pole</p> <p><i>Socket size refers to coordinating rod diameter. This socket is to be paired with an open ended socket.</i></p>	<ul style="list-style-type: none"> • Bronze - 66 • Vintage - 84 • Cast Iron - 818 • Antique Gold - 418 • Rustic - 624 • Aged Silver - 106 	5
	<p>Closed End Socket HDW20246</p> <p>1 5/8" W Designed for 1 1/2" Dia. Pole</p> <p><i>Socket size refers to coordinating rod diameter. This socket is to be paired with an open ended socket.</i></p>	<ul style="list-style-type: none"> • Bronze - 66 • Vintage - 84 • Cast Iron - 818 • Antique Gold - 418 • Rustic - 624 • Aged Silver - 106 	5
	<p>Open End Socket HDW20241</p> <p>1 1/8" W Designed for 3/4" Dia. Pole</p> <p><i>Socket size refers to coordinating rod diameter. This socket is to be paired with a closed end socket.</i></p>	<ul style="list-style-type: none"> • Bronze - 66 • Vintage - 84 • Cast Iron - 818 • Antique Gold - 418 • Rustic - 624 • Aged Silver - 106 	5

NEW! Rustic Iron Collection can be specially treated for outdoor use with an upcharge.
(Rustic Iron Traversing cannot be treated for outdoor use.)

Custom

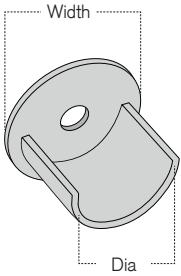
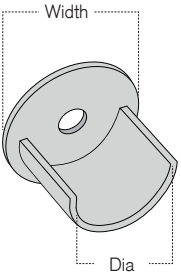
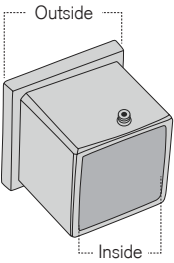
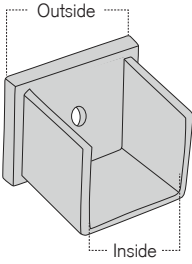
	Styles / Specifications	Available Finishes	Catalog Pg.
	<p>Open End Socket HDW20242</p> <p>1 1/8" W Designed for 1" Dia. Pole</p> <p><i>Socket size refers to coordinating rod diameter. This socket is to be paired with a closed end socket.</i></p>	<ul style="list-style-type: none"> • Bronze - 66 • Vintage - 84 • Cast Iron - 818 • Antique Gold - 418 • Rustic - 624 • Aged Silver - 106 	5
	<p>Open End Socket HDW20243</p> <p>1 5/8" W Designed for 1 1/2" Dia. Pole</p> <p><i>Socket size refers to coordinating rod diameter. This socket is to be paired with a closed end socket.</i></p>	<ul style="list-style-type: none"> • Bronze - 66 • Vintage - 84 • Cast Iron - 818 • Antique Gold - 418 • Rustic - 624 • Aged Silver - 106 	5
	<p>Closed End Socket Square HDW20248</p> <p>1 1/4" Outside W 1 1/8" Inside W</p> <p><i>Socket size refers to coordinating rod diameter. This socket is to be paired with an open ended socket.</i></p>	<ul style="list-style-type: none"> • Bronze - 66 • Vintage - 84 • Cast Iron - 818 • Antique Gold - 418 • Rustic - 624 • Aged Silver - 106 	5
	<p>Open End Socket Square HDW20247</p> <p>1 1/4" Outside W 1 1/8" Inside W</p> <p><i>Socket size refers to coordinating rod diameter. This socket is to be paired with a closed end socket.</i></p>	<ul style="list-style-type: none"> • Bronze - 66 • Vintage - 84 • Cast Iron - 818 • Antique Gold - 418 • Rustic - 624 • Aged Silver - 106 	5

NEW! Rustic Iron Collection can be specially treated for outdoor use with an upcharge.
(Rustic Iron Traversing cannot be treated for outdoor use.)

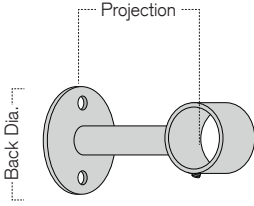
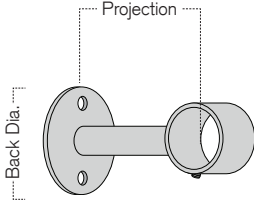
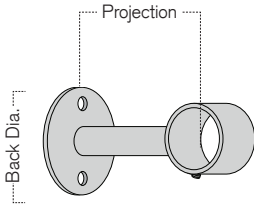
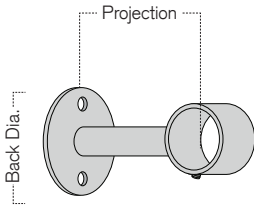
	Styles / Specifications	Available Finishes	Catalog Pg.
	<p>Cuff Bracket HDW20210</p> <p>2" Dia. Back x 1/8" Thick 3" Projection Designed for 3/4" Dia. Rod</p> <p><i>Cuff size refers to coordinating rod diameter</i></p>	<ul style="list-style-type: none"> • Bronze - 66 • Vintage - 84 • Cast Iron - 818 • Antique Gold - 418 • Rustic - 624 • Aged Silver - 106 	5
	<p>Cuff Bracket HDW20211</p> <p>2" Dia. Back x 1/8" Thick 3" Projection Designed for 7/8" Dia. Rod</p> <p><i>Cuff size refers to coordinating rod diameter</i></p>	<ul style="list-style-type: none"> • Bronze - 66 • Vintage - 84 • Cast Iron - 818 • Antique Gold - 418 • Rustic - 624 • Aged Silver - 106 	5
	<p>Cuff Bracket HDW20212</p> <p>2" Dia. Back x 1/8" Thick 3" Projection Designed for 1" Dia. Rod</p> <p><i>Cuff size refers to coordinating rod diameter</i></p>	<ul style="list-style-type: none"> • Bronze - 66 • Vintage - 84 • Cast Iron - 818 • Antique Gold - 418 • Rustic - 624 • Aged Silver - 106 	5
	<p>Cuff Bracket HDW20213</p> <p>2" Dia. Back x 1/8" Thick 3" Projection Designed for 1 1/2" Dia. Rod</p> <p><i>Cuff size refers to coordinating rod diameter</i></p>	<ul style="list-style-type: none"> • Bronze - 66 • Vintage - 84 • Cast Iron - 818 • Antique Gold - 418 • Rustic - 624 • Aged Silver - 106 	5

NEW! Rustic Iron Collection can be specially treated for outdoor use with an upcharge.
(Rustic Iron Traversing cannot be treated for outdoor use.)

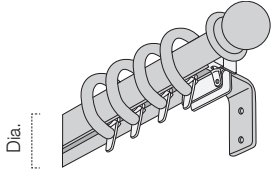
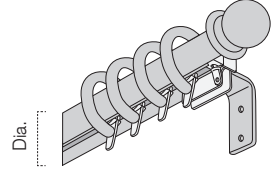
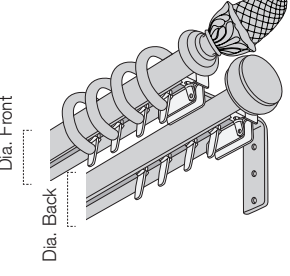
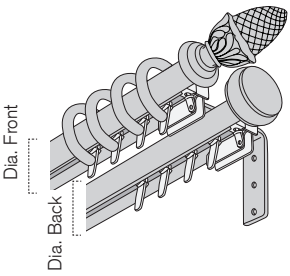

RUSTIC IRON TRAVERSING - Custom

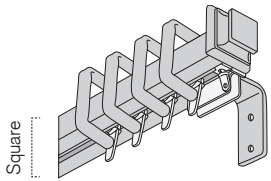
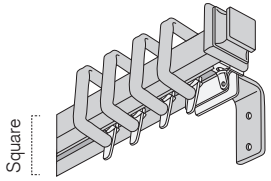
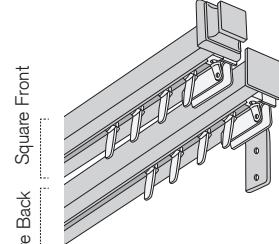
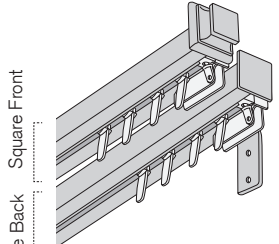
	Styles / Specifications	Available Finishes	Catalog Pg.
	<p>Single Round Traversing Rod Set (1st 3 ft.) HDW20261</p> <p>1 1/2" Dia. Rod</p> <p><i>(Minimum of 3ft traversing rod required) A set includes: rod, traverse track, 8ft of cord and pulley, end brackets, master carrier and (4 per ft) sub-carriers. Optional Ripplefold® carriers available, but must be specified, including fullness (60, 80, 100, 120). Rings sold separately, but NOT an option on Ripplefold® style. For additional traversing ft order HDW20262.</i></p>	<ul style="list-style-type: none"> • Bronze - 66 • Vintage - 84 • Cast Iron - 818 • Antique Gold - 418 • Rustic - 624 • Aged Silver - 106 	7
	<p>Each Additional Ft. of Single Round Traversing Rod Set HDW20262</p> <p>1 1/2" Dia. Rod</p> <p><i>Each additional ft includes: (4) sub-carriers. Optional Ripplefold® carriers available, but must be specified, including fullness (60, 80, 100, 120). Rings sold separately, but NOT an option on Ripplefold® style. Can only purchase additional ft in conjunction with ordering HDW20261.</i></p>	<ul style="list-style-type: none"> • Bronze - 66 • Vintage - 84 • Cast Iron - 818 • Antique Gold - 418 • Rustic - 624 • Aged Silver - 106 	7
	<p>Double Round Traversing Rod Set (1st 3 ft.) HDW20265</p> <p>1 1/2" Dia. Rod Front 1 1/4" Dia. Rod Back</p> <p><i>(Minimum of 3ft traversing rod required) A set includes: rod, traverse track, 8ft of cord and pulley, end brackets, master carrier and (4 per ft) sub-carriers. Optional Ripplefold® carriers available, but must be specified, including fullness (60, 80, 100, 120). Rings sold separately, but NOT an option on Ripplefold® style. For additional traversing ft order HDW20266.</i></p>	<ul style="list-style-type: none"> • Bronze - 66 • Vintage - 84 • Cast Iron - 818 • Antique Gold - 418 • Rustic - 624 • Aged Silver - 106 	7
	<p>Each Additional Ft. of Double Round Traversing Rod Set HDW20266</p> <p>1 1/2" Dia. Rod Front 1 1/4" Dia. Rod Back</p> <p><i>Each additional ft includes: (4) sub-carriers. Optional Ripplefold® carriers available, but must be specified, including fullness (60, 80, 100, 120). Rings sold separately, but NOT an option on Ripplefold® style. Can only purchase additional ft in conjunction with ordering HDW20265.</i></p>	<ul style="list-style-type: none"> • Bronze - 66 • Vintage - 84 • Cast Iron - 818 • Antique Gold - 418 • Rustic - 624 • Aged Silver - 106 	7

	Styles / Specifications	Available Finishes	Catalog Pg.
 <p>Square</p>	<p>Single Square Traversing Rod Set (1st 3 ft.) HDW20263</p> <p>1 1/2" Square Rod</p> <p><i>(Minimum of 3ft traversing rod required) A set includes: rod, traverse track, 8ft of cord and pulley, end brackets, master carrier and (4 per ft) sub-carriers. Optional Ripplefold[®] carriers available, but must be specified, including fullness (60, 80, 100, 120). Rings sold separately, but NOT an option on Ripplefold[®] style. For additional traversing ft order HDW20264.</i></p>	<ul style="list-style-type: none"> • Bronze - 66 • Vintage - 84 • Cast Iron - 818 • Antique Gold - 418 • Rustic - 624 • Aged Silver - 106 	<p>7</p>
 <p>Square</p>	<p>Each Additional Ft. of Single Square Traversing Rod Set HDW20264</p> <p>1 1/2" Square Rod</p> <p><i>Each additional ft includes: (4) sub-carriers. Optional Ripplefold[®] carriers available, but must be specified, including fullness (60, 80, 100, 120). Rings sold separately, but NOT an option on Ripplefold[®] style. Can only purchase additional ft in conjunction with ordering HDW20263.</i></p>	<ul style="list-style-type: none"> • Bronze - 66 • Vintage - 84 • Cast Iron - 818 • Antique Gold - 418 • Rustic - 624 • Aged Silver - 106 	<p>7</p>
 <p>Square Front</p> <p>Square Back</p>	<p>Double Square Traversing Rod Set (1st 3 ft.) HDW20267</p> <p>1 1/2" Square Rod Front 1 1/4" Square Rod Back</p> <p><i>(Minimum of 3ft traversing rod required) A set includes: rod, traverse track, 8ft of cord and pulley, end brackets, master carrier and (4 per ft) sub-carriers. Optional Ripplefold[®] carriers available, but must be specified, including fullness (60, 80, 100, 120). Rings sold separately, but NOT an option on Ripplefold[®] style. For additional traversing ft order HDW20268.</i></p>	<ul style="list-style-type: none"> • Bronze - 66 • Vintage - 84 • Cast Iron - 818 • Antique Gold - 418 • Rustic - 624 • Aged Silver - 106 	<p>7</p>
 <p>Square Front</p> <p>Square Back</p>	<p>Each Additional Ft. of Double Square Traversing Rod Set HDW20268</p> <p>1 1/2" Square Rod Front 1 1/4" Square Rod Back</p> <p><i>Each additional ft includes: (4) sub-carriers. Optional Ripplefold[®] carriers available, but must be specified, including fullness (60, 80, 100, 120). Rings sold separately, but NOT an option on Ripplefold[®] style. Can only purchase additional ft in conjunction with ordering HDW20267.</i></p>	<ul style="list-style-type: none"> • Bronze - 66 • Vintage - 84 • Cast Iron - 818 • Antique Gold - 418 • Rustic - 624 • Aged Silver - 106 	<p>7</p>

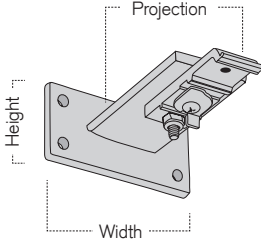
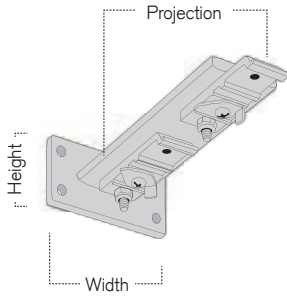
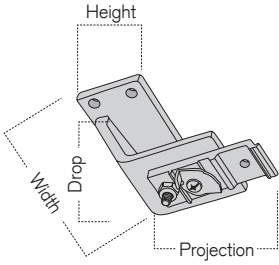
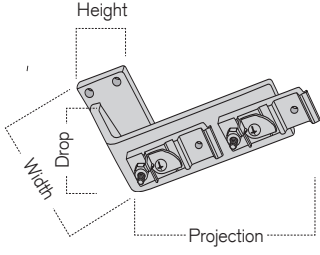
Custom

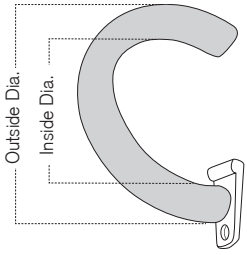
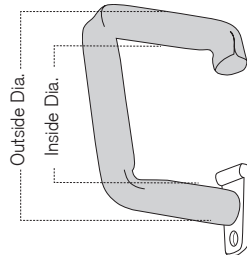
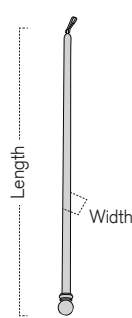
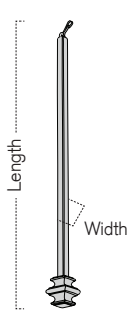
	Styles / Specifications	Available Finishes	Catalog Pg.
	<p>Single Wall Mount Bracket HDW20249</p> <p>1 5/8" H x 3" W 3 1/4"-4 1/2" Projection</p> <p><i>This heavy duty 1/4" thick bracket can be used for both manual and motorized traversing systems.</i></p>	<ul style="list-style-type: none"> • Bronze - 66 • Vintage - 84 • Cast Iron - 818 • Antique Gold - 418 • Rustic - 624 • Aged Silver - 106 	7
	<p>Double Wall Mount Bracket HDW20250</p> <p>1 5/8" H x 3" W 3" - 7 1/2" Projection</p> <p><i>This heavy duty 1/4" thick bracket can be used for both manual and motorized traversing systems.</i></p>	<ul style="list-style-type: none"> • Bronze - 66 • Vintage - 84 • Cast Iron - 818 • Antique Gold - 418 • Rustic - 624 • Aged Silver - 106 	7
	<p>Single Ceiling Mount Bracket HDW20251</p> <p>1 5/8" H x 3" W 3" Drop 3 1/4"-4 1/2" Projection</p> <p><i>This heavy duty 1/4" thick bracket can be used for both manual and motorized traversing systems.</i></p>	<ul style="list-style-type: none"> • Bronze - 66 • Vintage - 84 • Cast Iron - 818 • Antique Gold - 418 • Rustic - 624 • Aged Silver - 106 	7
	<p>Double Ceiling Mount Bracket HDW20252</p> <p>1 5/8" H x 3" W 3" Drop 3"-7 1/2" Projection</p> <p><i>This heavy duty 1/4" thick bracket can be used for both manual and motorized traversing systems.</i></p>	<ul style="list-style-type: none"> • Bronze - 66 • Vintage - 84 • Cast Iron - 818 • Antique Gold - 418 • Rustic - 624 • Aged Silver - 106 	7

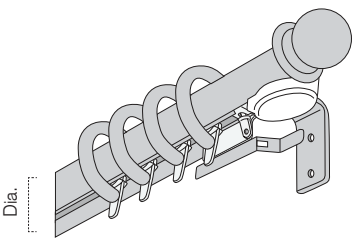
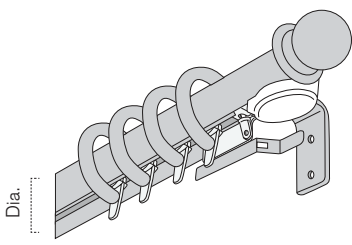
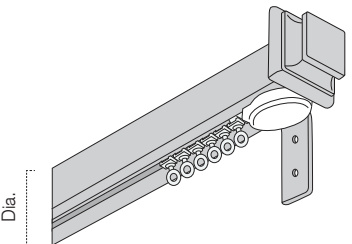
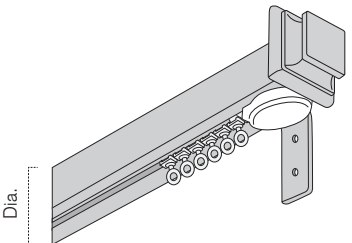

	Styles / Specifications	Available Finishes	Catalog Pg.
	<p>Round Iron C Ring HDW20257</p> <p>2 3/8" Inside Dia. 3 3/8" Outside Dia. 1/2" Thickness</p>	<ul style="list-style-type: none"> • Bronze - 66 • Vintage - 84 • Cast Iron - 818 • Antique Gold - 418 • Rustic - 624 • Aged Silver - 106 	7
	<p>Square Iron C Ring HDW20258</p> <p>2 1/8" Inside Dia. 3 1/8" Outside Dia. 1/2" Thickness</p>	<ul style="list-style-type: none"> • Bronze - 66 • Vintage - 84 • Cast Iron - 818 • Antique Gold - 418 • Rustic - 624 • Aged Silver - 106 	7
	<p>Iron Baton Round HDW20255</p> <p>48" L 1/2" Square Rod</p> <p><i>In lieu of cord pulley system, manual baton can be used.</i></p>	<ul style="list-style-type: none"> • Bronze - 66 • Vintage - 84 • Cast Iron - 818 • Antique Gold - 418 • Rustic - 624 • Aged Silver - 106 	7
	<p>Iron Baton Square HDW20256</p> <p>48" L 1/2" Square Rod</p> <p><i>In lieu of cord pulley system, manual baton can be used.</i></p>	<ul style="list-style-type: none"> • Bronze - 66 • Vintage - 84 • Cast Iron - 818 • Antique Gold - 418 • Rustic - 624 • Aged Silver - 106 	7
	<p>Additional Traversing Glides HDW20259</p> <p><i>See page 38 for glide style options.</i></p>	<ul style="list-style-type: none"> • Standard - 106 	7
NO IMAGE AVAILABLE	<p>Additional Cord HDW20260</p>	<ul style="list-style-type: none"> • White - 1 	7

NEW! RUSTIC IRON MOTORIZATION - Custom

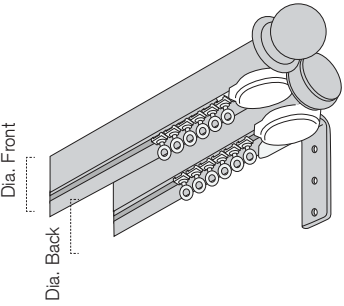
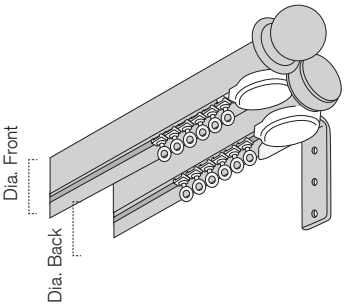
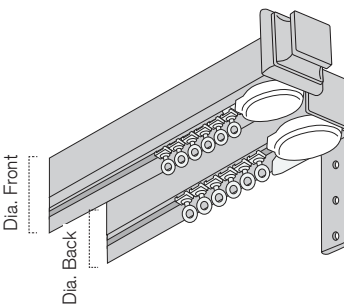
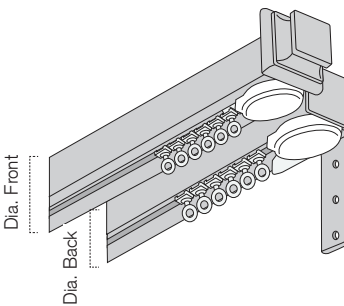
	Styles / Specifications	Available Finishes	Catalog Pg.
	<p>Single Round Motorized Rod Set (1st 3 ft.) HDW20390</p> <p>1 1/2" Dia. Rod</p> <p><i>(Minimum of 3ft traversing rod required) A set includes: rod, traverse track, Somfy® motor, end brackets, master carrier and (4 per ft) sub-carriers. Optional Ripplefold® carriers available, but must be specified, including fullness (60, 80, 100 or 120). Rings sold separately, but NOT an option on Ripplefold® style. Note: Fascia length is 1" longer than track length. (For more info, see drawing on page 38) For additional traversing ft order HDW20391</i></p>	<ul style="list-style-type: none"> • Bronze - 66 • Vintage - 84 • Cast Iron - 818 • Antique Gold - 418 • Rustic - 624 • Aged Silver - 106 	8
	<p>Each Additional Ft. of Single Round Motorized Rod Set HDW20391</p> <p>1 1/2" Dia. Rod</p> <p><i>Each additional ft includes: (4) sub-carriers. Optional Ripplefold® carriers available, but must be specified, including fullness (60, 80, 100 or 120). Rings sold separately, but NOT an option on Ripplefold® style. Can only purchase additional ft in conjunction with ordering HDW20390. Note: Fascia length is 1" longer than track length. (For more info, see drawing on page 38)</i></p>	<ul style="list-style-type: none"> • Bronze - 66 • Vintage - 84 • Cast Iron - 818 • Antique Gold - 418 • Rustic - 624 • Aged Silver - 106 	8
	<p>Single Square Motorized Rod Set (1st 3 ft.) HDW20394</p> <p>1 1/2" Dia. Rod</p> <p><i>(Minimum of 3ft traversing rod required) A set includes: rod, traverse track, Somfy® motor, end brackets, master carrier and (4 per ft) sub-carriers. Optional Ripplefold® carriers available, but must be specified, including fullness (60, 80, 100 or 120). Rings sold separately, but NOT an option on Ripplefold® style. Note: Fascia length is 1" longer than track length. (For more info, see drawing on page 38) For additional traversing ft order HDW20395</i></p>	<ul style="list-style-type: none"> • Bronze - 66 • Vintage - 84 • Cast Iron - 818 • Antique Gold - 418 • Rustic - 624 • Aged Silver - 106 	8
	<p>Each Additional Ft. of Single Square Motorized Rod Set HDW20395</p> <p>1 1/2" Dia. Rod</p> <p><i>Each additional ft includes: (4) sub-carriers. Optional Ripplefold® carriers available, but must be specified, including fullness (60, 80, 100 or 120). Rings sold separately, but NOT an option on Ripplefold® style. Can only purchase additional ft in conjunction with ordering HDW20394. Note: Fascia length is 1" longer than track length. (For more info, see drawing on page 38)</i></p>	<ul style="list-style-type: none"> • Bronze - 66 • Vintage - 84 • Cast Iron - 818 • Antique Gold - 418 • Rustic - 624 • Aged Silver - 106 	8

	Styles / Specifications	Available Finishes	Catalog Pg.
	<p>Double Round Motorized Rod Set (1st 3 ft.) HDW20392 1 1/2" Dia. Rod Front 1 1/4" Dia. Rod Back</p> <p><i>(Minimum of 3ft traversing rod required) A set includes: rod, traverse track, Somfy® motor, end brackets, master carrier and (4 per ft) sub-carriers. Optional Ripplefold® carriers available, but must be specified, including fullness (60, 80, 100 or 120). Rings sold separately, but NOT an option on Ripplefold® style. Note: Fascia length is 1" longer than track length. (For more info, see drawing on page 38) For additional traversing ft order HDW20393</i></p>	<ul style="list-style-type: none"> • Bronze - 66 • Vintage - 84 • Cast Iron - 818 • Antique Gold - 418 • Rustic - 624 • Aged Silver - 106 	<p>8</p>
	<p>Each Additional Ft. of Double Round Motorized Rod Set HDW20393 1 1/2" Dia. Rod Front 1 1/4" Dia. Rod Back</p> <p><i>Each additional ft includes: (4) sub-carriers. Optional Ripplefold® carriers available, but must be specified, including fullness (60, 80, 100 or 120). Rings sold separately, but NOT an option on Ripplefold® style. Can only purchase additional ft in conjunction with ordering HDW20392. Note: Fascia length is 1" longer than track length. (For more info, see drawing on page 38)</i></p>	<ul style="list-style-type: none"> • Bronze - 66 • Vintage - 84 • Cast Iron - 818 • Antique Gold - 418 • Rustic - 624 • Aged Silver - 106 	<p>8</p>
	<p>Double Square Motorized Rod Set (1st 3 ft.) HDW20396 1 1/2" Dia. Rod Front 1 1/4" Dia. Rod Back</p> <p><i>(Minimum of 3ft traversing rod required) A set includes: rod, traverse track, Somfy® motor, end brackets, master carrier and (4 per ft) sub-carriers. Optional Ripplefold® carriers available, but must be specified, including fullness (60, 80, 100 or 120). Rings sold separately, but NOT an option on Ripplefold® style. Note: Fascia length is 1" longer than track length. (For more info, see drawing on page 38) For additional traversing ft order HDW20397</i></p>	<ul style="list-style-type: none"> • Bronze - 66 • Vintage - 84 • Cast Iron - 818 • Antique Gold - 418 • Rustic - 624 • Aged Silver - 106 	<p>8</p>
	<p>Each Additional Ft. of Double Square Motorized Rod Set HDW20397 1 1/2" Dia. Rod Front 1 1/4" Dia. Rod Back</p> <p><i>Each additional ft includes: (4) sub-carriers. Optional Ripplefold® carriers available, but must be specified, including fullness (60, 80, 100 or 120). Rings sold separately, but NOT an option on Ripplefold® style. Can only purchase additional ft in conjunction with ordering HDW20396. Note: Fascia length is 1" longer than track length. (For more info, see drawing on page 38)</i></p>	<ul style="list-style-type: none"> • Bronze - 66 • Vintage - 84 • Cast Iron - 818 • Antique Gold - 418 • Rustic - 624 • Aged Silver - 106 	<p>8</p>

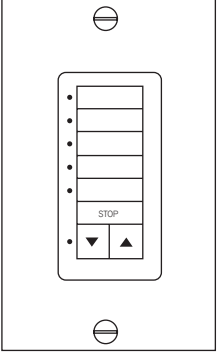
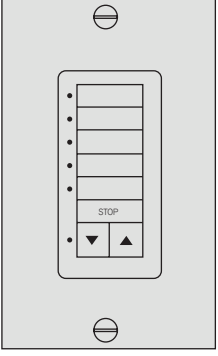
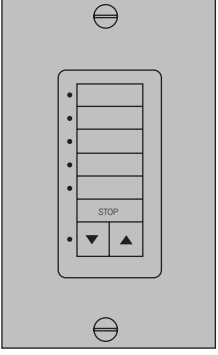
Custom

	Styles / Specifications	Available Finishes	Catalog Pg.
	<p>5 Channel Wall Mount Wireless Radio Technology HDW20403</p> <p><i>Battery-powered, no electrician needed. 5 channels allow for control of up to 5 individual motorized window coverings, or 5 groups of motorized window coverings, or a combination of the two. A control unit is required to operate motorization.</i></p>	<ul style="list-style-type: none"> • White 	<p>8/17</p>
	<p>5 Channel Wall Mount Wireless Radio Technology HDW20404</p> <p><i>Battery-powered, no electrician needed. 5 channels allow for control of up to 5 individual motorized window coverings, or 5 groups of motorized window coverings, or a combination of the two. A control unit is required to operate motorization.</i></p>	<ul style="list-style-type: none"> • Ivory 	<p>8/17</p>
	<p>5 Channel Wall Mount Wireless Radio Technology HDW20405</p> <p><i>Battery-powered, no electrician needed. 5 channels allow for control of up to 5 individual motorized window coverings, or 5 groups of motorized window coverings, or a combination of the two. A control unit is required to operate motorization.</i></p>	<ul style="list-style-type: none"> • Black 	<p>8/17</p>
	<p>Handheld 5 Channel Remote Wireless Radio Technology HDW20402</p> <p><i>Battery powered, 5 channels allow for control of up to 5 individual motorized window coverings, or 5 groups of motorized window coverings, or a combination of the two. A control unit is required to operate motorization.</i></p>	<ul style="list-style-type: none"> • Silver 	<p>8/17</p>

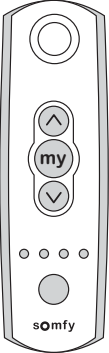
	Styles / Specifications	Available Finishes	Catalog Pg.
	<p>Handheld 5 Channel Remote Wireless Radio Technology HDW20386</p> <p><i>Battery powered, 5 channels allow for control of up to 5 individual motorized window coverings, or 5 groups of motorized window coverings, or a combination of the two. A control unit is required to operate motorization.</i></p>	<ul style="list-style-type: none"> • Black 	<p>8/17</p>
	<p>Handheld 5 Channel Remote Wireless Radio Technology HDW20387</p> <p><i>Battery powered, 5 channels allow for control of up to 5 individual motorized window coverings, or 5 groups of motorized window coverings, or a combination of the two. A control unit is required to operate motorization.</i></p>	<ul style="list-style-type: none"> • White 	<p>8/17</p>

SOMFY MOTORIZATION INFORMATION



Heavy duty master carrier

SUB-CARRIER STYLES

Pinch Pleat Carrier



PPC

Ripplefold® Carrier



RC

FEATURES/OPTIONS:

- Ultimate in home convenience
- For light to heavyweight draperies; Up to 36ft and 132 lbs
- Control single or multiple motorized draperies using the same remote
- Easy installation- Motor can be installed to the right or left side of the track
- Standard or inverse motor mounting available with 10 ft cord
- Belt driven track
- Motor design and the use of a timing belt provides quiet operation
- Automatic or adjustable settings
- Manual override; Disengages motor when adjusted manually- ideal for power outages
- Soft start and soft stop; adjustable speeds
- Patented cover design conceals unsightly cables and protects the connectors and control modules inside the motor
- Plug-in modules adapt to various technologies to easily integrate with home automation systems
- Patented flexible master carrier reduces friction and is adaptable to various drapery types
- Sub-carrier types will be determined by the style of draperies. Please specify the sub-carrier style when ordering, Ripplefold® available in 80, 100 and 120% fullness
- Ceiling mount installation available
- Wireless remote and wireless battery-powered wall mount controls are available and no electrician needed

MOTOR:

- Glydea™ 60e
- 5 year international warranty
- International certifications



FASCIA MEASUREMENT DETAILS

