

Jazz Deep Sectional

D218 LAS

One Arm Sofa

OVERALL: 96W x 40D x 39H

SEAT: 24D 20H

ARM: 24.5H

INSIDE: 90W

YARDAGE: 41 (54" Wide, Plain)

OPTIONS: Arm, Back, Base & Trim

Also Available: Standard Sectionals,
Standard & Deep Sofas,
Deep Sleeper Sofas,
Standard & Deep Chairs,
Ottomans

Available By the Inch
Custom Inquiries Invited

D218 RAH

One Arm Chaise

OVERALL: 37W x 68D x 39H

SEAT: 51D 20H

ARM: 24.5H

INSIDE: 31W

ARM: 1A 6" Track

BACK: 2B Low Border Straight

BASE: 3C Muse Wood

TRIM: Simple Seam

FINISHES & OPTIONS

 Maple Finishes

 Paint Finishes

 Arm, Back, Base, Trim



Jazz Options

ARMS *Arm 2A adds 2" to OW, Arm 3A add 4" to OW



1A 6" Track
OW: 6"



2A 8" Track*
OW: 8"



3A 10" Track*
OW: 10"



4A Wrap
OW: 6"

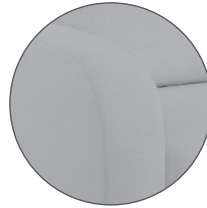

5A Radius
OW: 6"

BACKS BH: 31" OR 35"



1B Low Border
T-Back
OH: 35"



2B Low Border
Straight Back
OH: 35"



3B High Border
T-Back
OH: 39"



4B High Border
Straight Back
OH: 39"



5B Tight Back
OH: 35"

BASES Swivel Chairs available with Base to Floor (set 2" above floor) or Waterfall Skirt.

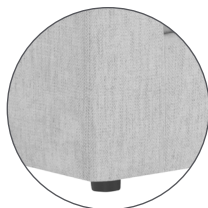

1C Base to Floor
OH: 2"
Hover Foot

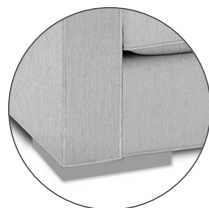

2C Chrome
OH: 2"

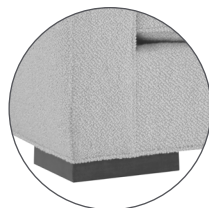

3C Muse Wood
OH: 2"

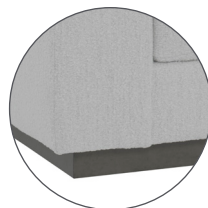

4C Plinth Base
OH: 3"
NA on QTR
(2.5" inset from uph)



5C Muse Natural Oak
OH: 2"
(Natural finish only)

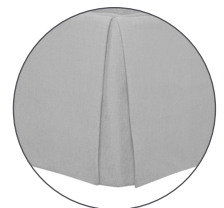

6C Waterfall Skirt

Jazz Options

TRIMS

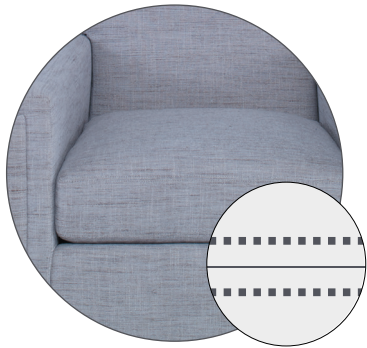

Baseball Stitch

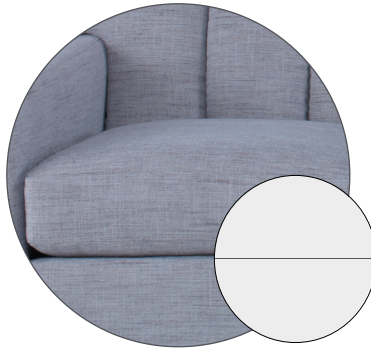

Simple Seam

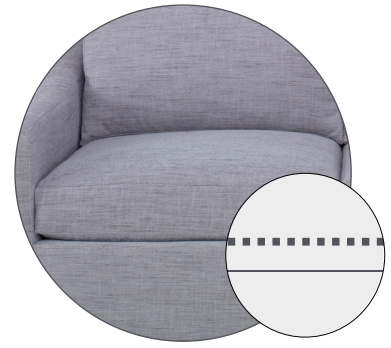

French Seam
(Top Stitch)

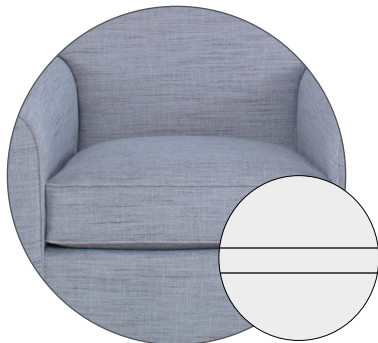

Bias Welt



Trim Cord with Lip
*Additional

FINISHES



Maple Finishes

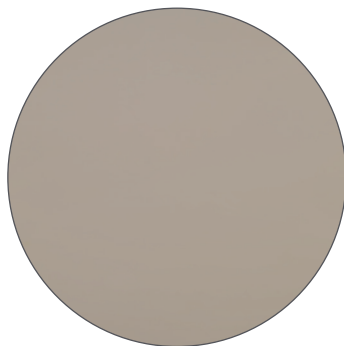

Paint Finishes

YARDAGE

Due to custom nature please contact sales for yardage requirements.

Jazz/Jazz Deep Schematics

seat depth

37" OD: 21" SD

40" OD: 24" SD / Sleeper Sectional 23" SD

height

Loose Back Overall Height: 35" or 39" / Sleeper Sectional 37" or 41"





Loose Back Frame Height: 31" or 33" / Sleeper Sectional 33" or 35"

Tight Back Overall Height: 35" / Sleeper Sectional 37"

Seat Height: 20" / Sleeper Sectional 22"





Arm Height: 24.5"

OTTOMAN FRAMES

			
23.5"D ○ D220 OTTO Ottoman	20"D ○ *D220-CUR Curved Ottoman	37"D ○ *D220-OCT Octagon Ottoman	32.5"D ○ D220-B Bumper Ottoman
OW: 32.5" OH: 19"	OW: 53" OH: 20"	OW: 37" OH: 37"	35.5"D ○ D218-B Bumper Ottoman OW: 29" OH: 20"



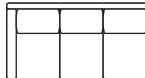
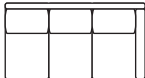

*Recessed Legs Standard - Ebony Finish Only

ONE ARM CHAIR and SOFA FRAMES *Arm 2A adds 2" to OW, Arm 3A add 4" to OW

					
37"D ○ D220 LC Left Arm Chair	○ D220 RC Right Arm Chair	○ D220 LAL Left Arm Loveseat	○ D220 RAL Right Arm Loveseat	○ D220 LAS Left Arm Sofa	○ D220 RAS Right Arm Sofa
40"D ○ D218 LC Left Arm Chair OW: 37" IW: 31"	○ D218 RC Right Arm Chair OW: 37" IW: 31"	○ D218 LAL Left Arm Loveseat OW: 67" IW: 61"	○ D218 RAL Right Arm Loveseat OW: 67" IW: 61"	○ *D218 LAS Left Arm Sofa OW: 96" IW: 90"	○ *D218 RAS Right Arm Sofa OW: 96" IW: 90"

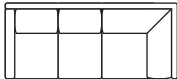
*Left/Right Arm Sleeper Sofa: D218S LQS, D218S RQS Must order all other skus as D218S to adjust to meet Sleeper

ONE ARM CORNER SOFA FRAME and CHAISE FRAMES *Arm 2A adds 2" to OW, Arm 3A add 4" to OW

			
37"D ○ D220 LCS Left Arm Corner Sofa OW: 104" IW: 82"	○ D220 RCS Right Arm Corner Sofa OW: 104" IW: 82"	○ D220 LAH Left Arm Chaise OW: 37" OD: 65" SD: 49" IW: 31"	○ D220 RAH Right Arm Chaise OW: 37" OD: 65" SD: 49" IW: 31"
40"D ○ D218 LCS Left Arm Corner Sofa OW: 104" IW: 82"	○ D218 RCS Right Arm Corner Sofa OW: 104" IW: 82"	○ D218 LAH Left Arm Chaise OW: 37" OD: 68" SD: 52" IW: 31"	○ D218 RAH Right Arm Chaise OW: 37" OD: 68" SD: 52" IW: 31"

Jazz/Jazz Deep Schematics

ARMLESS RETURN SOFA FRAMES and BUMPER END SOFA FRAMES

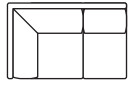

37"D D220 LRL Armless Left Return Loveseat
OW: 67"
IW: 51"

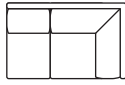

D220 RRL Armless Right Return Loveseat
OW: 67"
IW: 51"

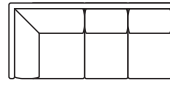

D220 LRS Armless Left Return Sofa
OW: 97"
IW: 81"

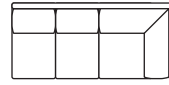

D220 RRS Armless Right Return Sofa
OW: 97"
IW: 81"

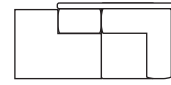

D220 LCH Armless Left Bumper End Sofa
OW: 95"
IW: 79"

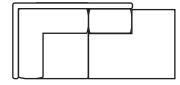

D220 RCH Armless Right Bumper End Sofa
OW: 95"
IW: 79"

40"D D218 LRL Armless Left Return Loveseat
OW: 70"
IW: 54"

D218 RRL Armless Right Return Loveseat
OW: 70"
IW: 54"

D218 LRS Armless Left Return Sofa
OW: 100"
IW: 84"

D218 RRS Armless Right Return Sofa
OW: 100"
IW: 84"

D218 LCH Armless Left Bumper End Sofa
OW: 98"
IW: 82"

D218 RCH Armless Right Bumper End Sofa
OW: 98"
IW: 82"

CONNECTING CORNER FRAMES *Arm 2A adds 2" to OW, Arm 3A add 4" to OW



37"D D220 CC Corner Chair
OW: 37"
IW: 21"



D220 QTR Quarter Turn
OW: 53"



D220 WDG Armless Wedge
OW: 70" x 70"



D220 LWDG Left Arm Wedge
OW: 75" x 70"



D220 RWDG Right Arm Wedge
OW: 75" x 70"

40"D D218 CC Corner Chair
OW: 40"
IW: 24"

D218 QTR Quarter Turn
OW: 56"

D218 WDG Armless Wedge
OW: 73" x 73"

D218 LWDG Left Arm Wedge
OW: 78" x 73"

D218 RWDG Right Arm Wedge
OW: 78" x 73"

ARMLESS CHAIR and SOFA FRAMES



37"D D220 AC Armless Chair



D220 ALS Armless Loveseat

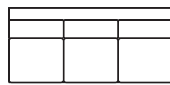

D220 AS Armless Sofa

40"D D218 AC Armless Chair
OW: 30"
IW: 30"

D218 ALS Armless Loveseat
OW: 52"
IW: 52"

D218 AS Armless Sofa
OW: 78"
IW: 78"