

Jazz Deep Sectional

D218 LAS E 83 P

One Arm Sofa

OVERALL: 96W x 40D x 39H

SEAT: 24D 20H

ARM: 24.5H

INSIDE: 90W

D218 RAH E 83 P

One Arm Chaise

OVERALL: 37W x 68D x 39H

SEAT: 51D 20H

ARM: 24.5H

INSIDE: 31W

FINISHES

 Maple Finishes

 Paint Finishes

YARDAGE: 41 (54" Wide, Plain)

OPTIONS: Back & Base

Also Available: Standard Sectionals, Standard & Deep Sofas, Deep Sleeper Sofas,
Standard & Deep Chairs, Ottomans

Available By the Inch

Custom Inquiries Invited



Jazz/Jazz Deep Sectionals Options

ARM



E • Tuxedo

***WELTLESS BACKS** Baseball Stitch Standard. Bias Welt or Blind Stitch can be applied for no additional charge.



72 • Low T Border
Entire Piece is Weltless
OH: 35" SH: 20"



73 • Low Border
Entire Piece is Weltless
OH: 35" SH: 20"

*Sleeper Sectional OH 37"

***WELTED BACKS** Bias Welt Standard. Baseball Stitch or Blind Stitch can be applied for no additional charge.



82 • High T Border
Entire Piece is Welted
OH: 39" SH: 20"



83 • High Border
Entire Piece is Welted
OH: 39" SH: 20"

*Sleeper Sectional OH 41"

FEET

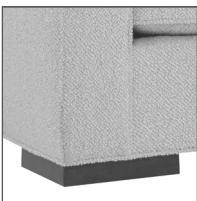

BL • Muse Wood
Flat Front

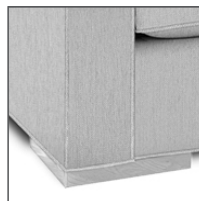

CH • Chrome

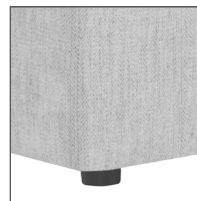

HO • Hover Recessed
*Ebony Finish Only

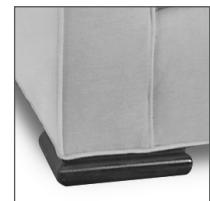

P • Platform
Bullnose Front

kravet DESIGN

Jazz Deep Schematics D218

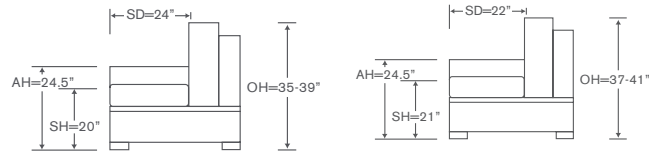

*Sleeper Sectional

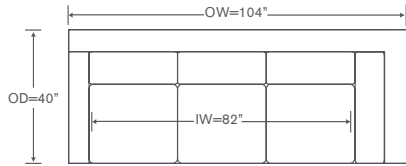

Left/Right Corner Sofa
D218 LCS/RCS

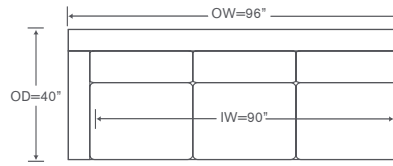

Left/Right Sofa
D218 LAS/RAS

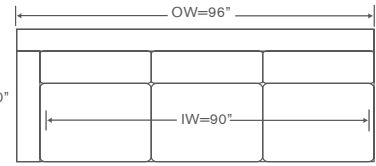

Left/Right Queen Sleeper
*D218S LQS/RQS

*See above for Sleeper Sectional Dimensions
Must order all other skus as D218S to adjust to meet Sleeper

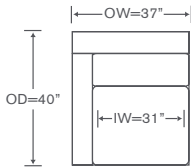

Left/Right Chair
D218 LC/RC

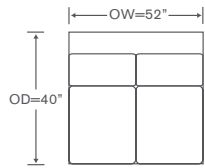

Armless Loveseat
D218 ALS

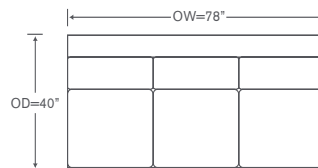

Armless Sofa
D218 AS

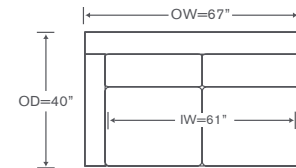

Left/Right Loveseat
D218 LAL/RAL

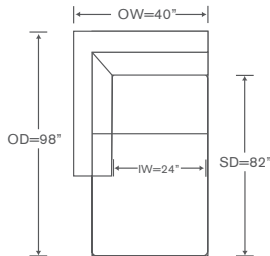

Left/Right Armless
Return Chaise
D218 LCH/RCH

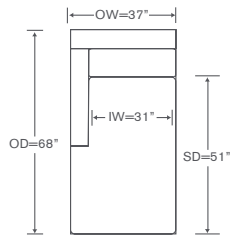

Left/Right Chaise
D218 LAH/RAH

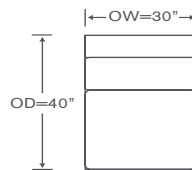

Armless Chair
D218 AC

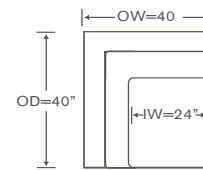

Corner Chair
D218 CC

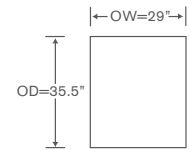

Bumper Ottoman
D218-B

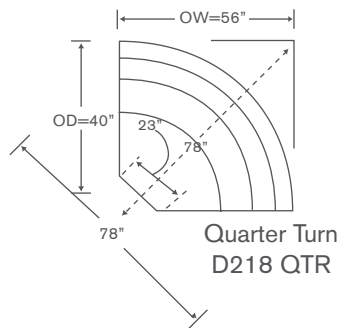

Quarter Turn
D218 QTR

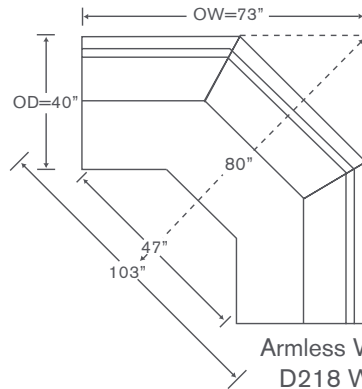

Armless Wedge
D218 WDG

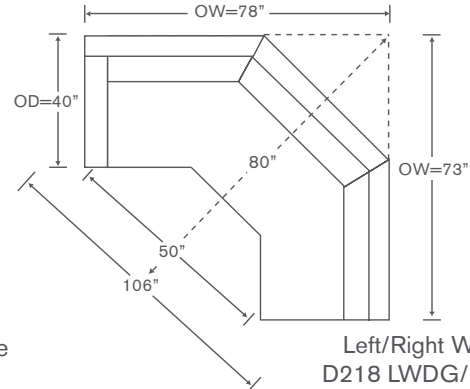

Left/Right Wedge
D218 LWDG/RWDG

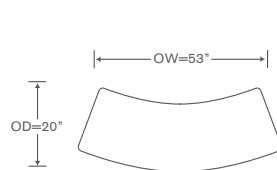

*Curved Ottoman
D220-CUR

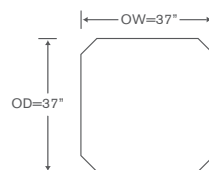

*Octagon Ottoman
D220-OCT

*Recessed Legs Standard - Ebony Finish Only

kravet DESIGN

Jazz Standard Schematics D220

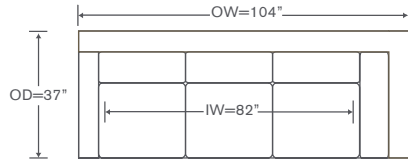
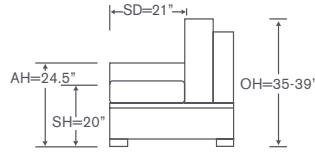

Left/Right Corner Sofa
D220 LCS/RCS

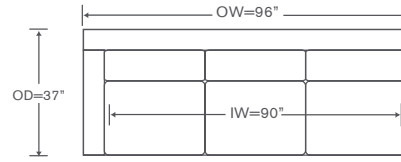

Left/Right Sofa
D220 LAS/RAS

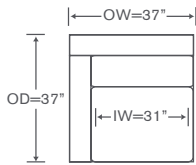

Left/Right Chair
D220 LC/RC

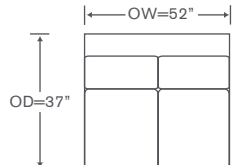

Armless Loveseat
D220 ALS

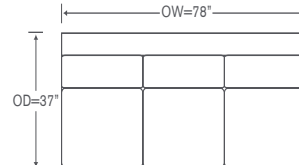

Armless Sofa
D220 AS

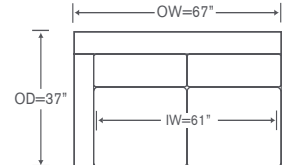

Left/Right Loveseat
D220 LAL/RAL

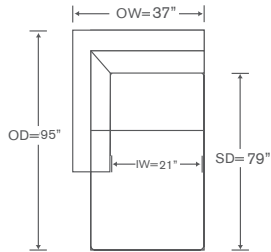

Left/Right Armless
Return Chaise
D220 LCH/RCH

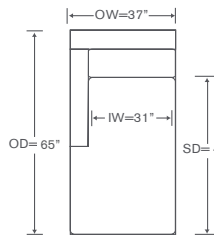

Left/Right Chaise
D220 LAH/RAH

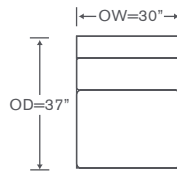

Armless Chair
D220 AC

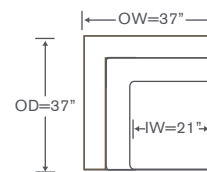

Corner Chair
D220 CC

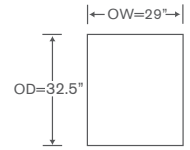

Bumper Ottoman
D220-B

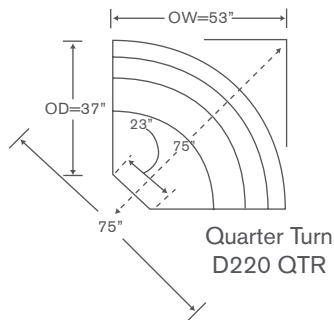

Quarter Turn
D220 QTR

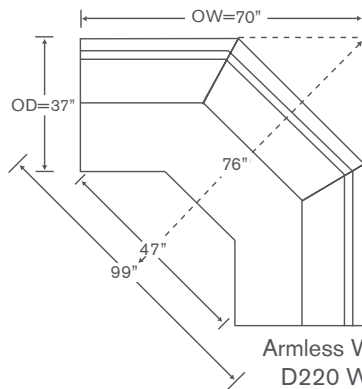

Armless Wedge
D220 WDG

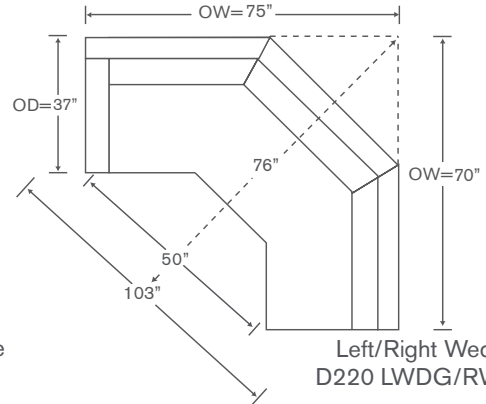

Left/Right Wedge
D220 LWDG/RWDG

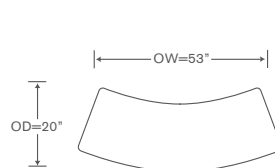

*Curved Ottoman
D220-CUR

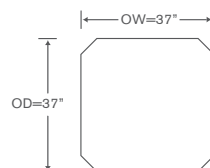

*Octagon Ottoman
D220-OCT

*Recessed Legs Standard - Ebony Finish Only